

Science and Technology Create Perfection

Installation and Operating Manual

SR1168 SOLAR CONTROLLER

For Split Pressurized Hot Water System



⚠ Read the instruction carefully please before operation!

Contents

| | |
|---|----|
| 1. Safety information | 5 |
| 1.1 Installation and commissioning..... | 5 |
| 1.2 About this manual..... | 5 |
| 1.3 Liability waiver | 5 |
| 1.4 Important remark..... | 6 |
| 1.5 Description of symbols..... | 6 |
| Overview | 6 |
| 2.1 Introduction of controller | 6 |
| 2.2 Scope of delivery | 7 |
| 2.3 Technical data | 7 |
| 3. Installation..... | 8 |
| 3.1 Installing controller | 8 |
| 3.2 Wire arrangement..... | 8 |
| 3.3 Wire connection | 9 |
| 4. Commissioning | 11 |
| 4.1 SCH system selection..... | 11 |
| 4.2 Menu structure | 12 |
| 4.3 Menu description..... | 13 |
| 4.4 System overview | 14 |
| 4.5 System description..... | 14 |
| SCH 1 (Standard solar system, 1 Storage) | 15 |
| SCH 2 (1 Storage, T - valve layer heating) | 16 |
| SCH 3 (Standard system, heat exchanger control logic) | 17 |
| SCH 4 (2 Storages, heat transferring control logic) | 18 |
| SCH 5 (2 Storages, Pump control logic) | 19 |
| SCH 6 (East/west collectors, 1 storage) | 20 |

| | |
|--|----|
| SCH 7 (1 storages , Heating-return control logic) | 21 |
| SCH 8 (2 storages, Heating-return control logic) | 22 |
| SCH 9 (2 storages, Heat inter-transferring control logic) | 23 |
| 5. Function operation and parameter setup (user grade)..... | 24 |
| 5.1 Set time/week | 24 |
| 5.2 THET Timing Heating..... | 24 |
| 5.3 CIRC DHW pump control function..... | 28 |
| 6. function operation and parameter setup (engineer grade)..... | 33 |
| 6.1 Access main menu..... | 33 |
| 6.2 DT Temperature difference..... | 33 |
| 6.3 TEMP Temperature..... | 34 |
| 6.3.1 EMOF Collector maximum switch-off temperature (for collector emergency close function)..... | 36 |
| 6.3.2 EMON Collector maximum switch-on temperature (for collector emergency close function)..... | 36 |
| 6.3.3 CMX Maximum limited collector temperature (collector cooling function)..... | 37 |
| 6.3.4 CMN low temperature protection of collector | 38 |
| 6.3.5 CFR frost protection of collector | 39 |
| 6.3.6 REC Storage re-cooling function | 40 |
| 6.3.7 SMX1 Maximum temperature of tank 1 | 40 |
| 6.3.8 SMX2 Maximum temperature of tank 2..... | 41 |
| 6.3.9 MAX1 Maximum switch-off temperature (for heat transferring between tank and heating loop) | 41 |
| 6.3.10 MIN1 Minimum switch-on temperature (for heat transferring between tank and heating loop) | 42 |
| 6.3.11 MAX2 Maximum switch-off temperature (for heat transferring between tank and heat exchanger) | 42 |
| 6.3.12 MIN2 Minimum switch-on temperature (for heat transferring between tank and heat exchanger)..... | 43 |
| 6.3.13 T2ON Switch-on temperature for pump transferring heat from storage 1 to storage 2..... | 43 |

| | |
|--|----|
| 6.3.14 T2OFF Switch-off temperature for pump transferring heat from storage 1 to storage 2 | 44 |
| 6.3.15 T4ON Switch-on temperature for pump transferring heat from storage 2 to storage 1 | 44 |
| 6.3.16 T4OFF Switch-off temperature for pump transferring heat from storage 2 to storage 1 | 45 |
| 6.4 PUMP circuit pump speed adjust set | 45 |
| 6.4.1 DTS Standard temperature difference for circulation pump 1 (speed adjusting) | 46 |
| 6.4.2 RIS Gain for circulation pump 1 (speed adjusting)..... | 46 |
| 6.4.3 n2MN Speed adjusting of circulation pump 2 (pump2 RPM controlling) | 47 |
| 6.4.4 DT2S Standard temperature difference for circulation pump 2 (speed adjusting)..... | 47 |
| 6.4.5 RIS2 Gain for circulation pump 2 (speed adjusting)..... | 48 |
| 6.5 OHQM Thermal energy measuring | 48 |
| 6.5.1 FMAX Flow rate | 50 |
| 6.5.2 MEDT Type of heat transfer liquid | 50 |
| 6.5.3 MED% Concentration of heat transfer liquid | 51 |
| 6.6 PRIO Tank priority..... | 51 |
| 6.6.1 tRUN Interval heating timer | 52 |
| 6.6.2 tSTP Interval switch-off time | 53 |
| 6.7 INTV Pump interval function..... | 53 |
| 6.7.1 ISTAR Turn-on time set for pump interval running function..... | 54 |
| 6.7.2 IEND Turn-off time set for pump interval running function | 54 |
| 6.7.3 ISTP Pump interval time..... | 55 |
| 6.7.4 IRUN Pump running time | 55 |
| 6.8 SFB Solid fuel boiler turn on/off..... | 55 |
| 6.8.1 SFON Minimum turn-on temperature of tank..... | 56 |
| 6.8.2 SFOF Maximum turn-off temperature of tank..... | 56 |
| 6.8.3 MAX3 Maximum turn-off temperature of solid fuel boiler | 57 |
| 6.8.4 MIN3 Maximum turn-on temperature of solid fuel boiler..... | 57 |

| | |
|---|----|
| 6.9 FUN Auxiliary function | 57 |
| 6.9.1 DVWG Anti legionnaires' function..... | 58 |
| 6.9.2 FTYPE Flow counter type selection..... | 59 |
| 6.9.3 COOL Tank cooling function..... | 59 |
| 6.9.4 AHO Auto thermostat function | 60 |
| 6.10 OSDC SD card data save function | 62 |
| 6.10.1 OSDC Card function switch-on and off | 62 |
| 6.10.2 LOGI Data save intervals | 62 |
| 6.11 UNIT Display unit °C and °F switches..... | 63 |
| 6.12 HND Manual control..... | 63 |
| 6.13 REST Recovery to factory set..... | 65 |
| 6.14 PASS Password set..... | 65 |
| 7. Button function | 66 |
| 7.1 Holiday function | 66 |
| 7.2 Manual heating..... | 67 |
| 7.3 Temperature query function | 68 |
| 8. Protection function | 68 |
| 8.1. Memory protection..... | 68 |
| 8.2 Screen protection..... | 68 |
| 8.3 Circuit pump protection | 68 |
| 9. Trouble shooting..... | 69 |
| 9.1 Trouble protection..... | 69 |
| 9.2 Trouble checking..... | 69 |
| 10. Quality Guarantee | 71 |
| 11. Accessories..... | 71 |

1. Safety information

1.1 Installation and commissioning

- When laying cables, please ensure that no damage occurs to any of the constructional fire safety measures presented in the building.
- The controller must not be installed in rooms where easily inflammable gas mixtures are present or may occur.
- The permissible environmental conditions can't be exceeded at the site of installation.
- Before connecting the device, make sure that the energy supply matches the specifications that controller requires.
- All devices connected to the controller must conform to the technical specifications of the controller.
- All operations on an open regulator are only to be conducted cleared from the power supply. All safety regulations for working on the power supply are valid.
- Connecting and /or all operations that require opening the regulator (e.g. changing the fuse) are only conducted by specialists.

1.2 About this manual

This manual describes the installation, function and operation of a solar thermal controller. When installing the remaining components e.g. the solar collectors, pump assemblies and the storage unit, it should be sure to observe the appropriate installation instructions provided by each manufacturer. Only trained professional personnel may perform installation, electrical connection, commissioning and maintenance of the device. The professional personnel must be familiar with this manual and follow the instructions contained herein.

1.3 Liability waiver

The manufacturer cannot monitor the compliance with these instructions or the circumstances and methods used for installation, operation, utilization and maintenance of this controller. Improper installation can cause damages to material and person. This is the reason why we do not take over responsibility and liability for losses, damages or cost that might arise due to improper installation, operation or wrong utilization and maintenance or that occurs in some connection with the aforementioned. Moreover we do not take over liability for patent infringements or infringements – occurring in connection with the use of this controller- on third parties rights. The manufacturer preserves the right to put changes to product, technical data or installation and operation instructions without prior notice. As soon as it becomes evident that safe operation is no longer possible (e.g. visible damage). Please immediate take the device out of operation. Note: ensure that the device cannot be accidentally placed into operation.

1.4 Important remark

We have carefully checked the text and pictures of this manual and provided the best of our knowledge and ideas, however inevitable errors maybe exist. Please note that we cannot guarantee that this manual is given in the integrity of image and text, they are just some examples, and they apply only to our own system. Incorrect, incomplete and erroneous information and the resulting damage we do not take responsibility.

1.5 Description of symbols



Safety instruction:

The safety instructions in the manual are marked with a warning triangle. They indicate measures, which can lead to personal injury and safety risks.

Operation steps: small triangle “▶” is used to indicate operation step.

Notes: Contains important information about operation or function.

Overview

2.1 Introduction of controller

- LCD display
- 7 sensor inputs
- 2 relay outputs
- 2 PWM outputs for speed control of pump
- Data saved on SD card
- RS485 remote control
- Timing and temperature set point control function
- Energy saved on/off operation model

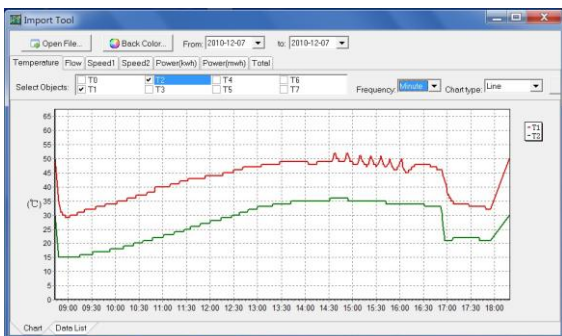

Picture1



Picture 2

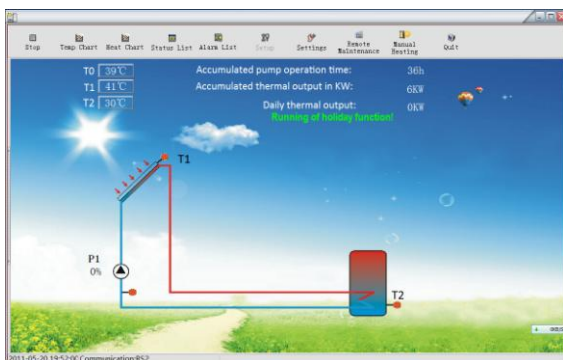

Picture 3

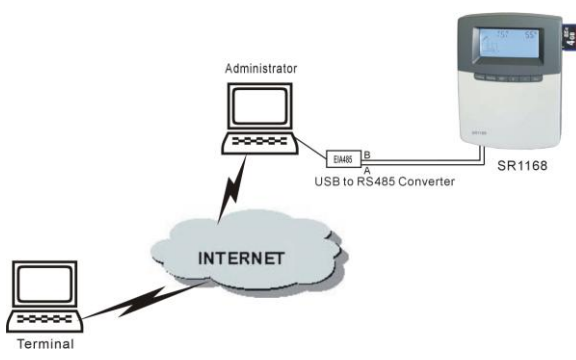

Picture 4

2.2 Scope of delivery

- 1 x controller
- 1 x user manual
- 2 x screw and dowel
- 2 x PT1000 sensor (φ6*50mm,length of cable 1.5 meter)
- 5 x NTC10K (φ6*50mm, length of cable 3 meter)
- 1 x bag of strain relief

2.3 Technical data

- Material of cases: ABS
- Available ambient temperature: 0 ... 40 °C
- Dimensions: 188 x 138 x 43 mm
- Mounting: on wall or in the electrical cases
- Operation button: 6 operation buttons on panel
- Functions: controller used in solar hot water system and solar heating system, has functions like temperature difference control, thermal energy measuring, accumulated running time of solar circuit pump, collector interval function, thermostat, storage layer heated, priority logic, back-up heating, heat transferring, Anti-Legionella function, PWM pump speed etc.
- Communication port: SD card groove.
- Power supply: 100 ... 240V ~, 50 ... 60 H z
- Power consumption : < 1W
- Accuracy of temperature measuring : ±2°C
- Range of collector temperature measuring: -20- 200°C
- Range of tank or pipe temperature measuring: 0-110°C
- Inputs: 2 x Pt1000 sensor (≤500°C) for collector (silicon cable≤280°C),

- 5 x NTC10K, B3950 sensor ($\leq 135^{\circ}\text{C}$) for tank, (PVC cable $\leq 105^{\circ}\text{C}$),
- 1 x RS485 remote control connection
- Outputs: 2 PWM outputs ($\leq 200\text{W}$) ; 2 relays outputs (each available power $\leq 300\text{W}$)
- Ambient temperature: $-10\text{--}50^{\circ}\text{C}$
- Water proof grade: IP40

Note: SD card isn't included within the delivery scope of controller.

3. Installation

Controller can only be installed indoors, far away from dangerous place and away from the electromagnetic field.

3.1 Installing controller

Note: the controller can only be mounted in an area having an adequate level of protection.

- ▶ Determine the mounting site of controller.
- ▶ Drill the upper fixing hole on the wall.
- ▶ Fasten a screw.
- ▶ Move the terminal cover
- ▶ Hang the base plate on the position ① (showed in picture)
- ▶ Mark the position of 2 bottom holes ②
- ▶ Remove the base plate
- ▶ Drill the bottom fixing hole
- ▶ Rehang the base plate on screw ①
- ▶ Fasted screw on ② and fix base plate.



3.2 Wire arrangement

Depending on the type of installation, the cables may enter the controller through the rear hole of the case A or the lower side hole of the case B.

Cable comes from the rear hole A: Remove the plastic flaps from the rear side of the case using an appropriate tool.

Cable comes from the below hole B: Cut the left and right plastic flaps using an appropriate tool (e.g. knife) and break them out of the case.

Notes: the flexible wire must be fastened on the case using the clamps provided

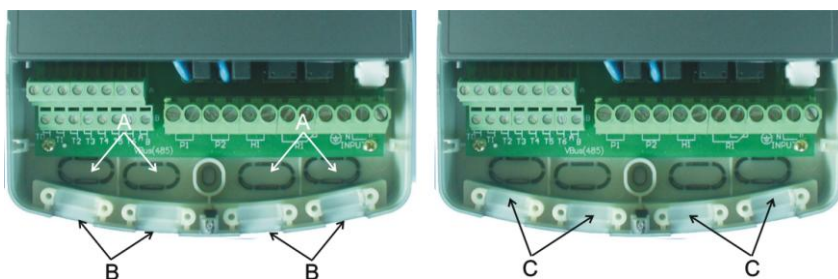

3.3 Wire connection



Before opening the terminal, please be sure to switch-off the power and pay attention to the local electricity supply rules.

Input ports

Input Ports:

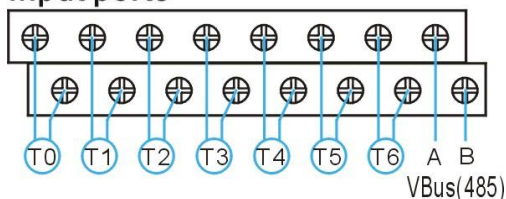

Inputs T0~T1: For PT1000 temperature sensor, used for measuring the temperature of collector and measuring the produced. thermal energy.

Inputs T2~T6: for NTC10K, B=3950 temperature sensor, used for measuring the temperature of storage or pipe.

VBus (485): for RS485 remote control connection.

● Advice regarding the installation of temperature sensors

- Only original factory enclosed Pt1000 temperature sensors are approved for use with the collector, it is equipped with 1.5meter silicon cable and suitable for all weather conditions, the temperature sensor and cable are temperature resistant up to 280^oC, not necessary to distinguish the positive and negative polarity of the sensor connection.
- Only original factory enclosed NTC10K, B=3950 temperature sensors are approved for use with tank and pipe, it is equipped with 1.5meter PVC cable, and they are temperature resistant up to 105^oC, not necessary to distinguish the positive and negative polarity of the sensor connection.

- All sensor cables carry low voltage, and to avoid inductive effects, must not be laid close to 230 volt or 400-volt cables (minimum separation of 100mm)
- If external inductive effects are existed, e.g. from heavy current cables, overhead train cables, transformer substations, radio and television devices, amateur radio stations, microwave devices etc, then the cables to the sensors must be adequately shielded.
- Sensor cables may be extended to a maximum length of ca. 100 meter, when cable's length is up to 50m, and then 0.75mm^2 cable should be used. When cable's length is up to 100m, and then 1.5mm^2 cable should be used.

● **Output Ports**

Output ports

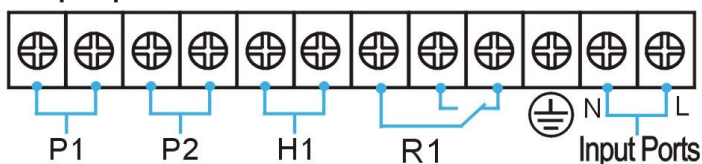

Input Ports: Input ports L, N is power connection terminal, please connect correctly.

 is Ground line terminal.

Output P1: Semiconductor relay (SCR relay), for solar circuit pump, also suitable for RPM (speed) control; Max. Switching current: 1A.

Output P2: Semiconductor relay (SCR relay), for solar circuit pump, also suitable for RPM (speed) control; Max. Switching current: 1A.

Output H1: Electromagnetic relay and Max. Switching current 3.5A,

Output R1: Electromagnetic relay and Max. Switching current 3.5A, for T type electromagnetic valve

Note:

- R1 used for controlling the electromagnetic valve, and “COM NC” is always the closed port, “COM NO” is always the open port.
- If this port is used for control circuit pump , Circuit pump is connected to port “COM NO” (always open valve).
- Depending on the solar system selection, pump and sensors should be connected to the controller are different, all wires should be installed in protection pipe.

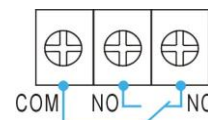

4. Commissioning



Connect the sensors, pumps or switching valves to the controller before you connect the power supply! After switching on power to the controller, firstly it will ask for to set the time, password and parameters of system.

4.1 SCH system selection

Under standby status,

▶ Press “SET” button, and then press “+” button, PWD 0000 appears on the screen, then press “SET” again, and the left digital blinks, it asks for entering password (default password is 0000).



▶ Press “+” “-” button to enter the first digital of password.

▶ Then press “SET” button, the second digital blinks,

▶ Press “+” “-” button to enter the second digital of password.



▶ Then press “SET” again, the third digital blinks,

▶ Press “+” “-” button to enter the third digital of password.

▶ Then press “SET” again, the forth digital blinks,

▶ Press “+” “-” button to enter the forth digital of password.

▶ After password entering, then press “SET” to enter main menu, “SCH 01” appears on the screen.

▶ Repress “SET” to select system, “01” blinks, and the first solar system showed on the screen.

▶ Press “+” “-” button, to scroll the solar system and select one suitable for your system. SCH1 to SCH9 systems are available.

▶ Press “ESC” to exit system setup, or wait for 20 seconds to exit set program automatically, the selected system is saved automatically.

4.2 Menu structure

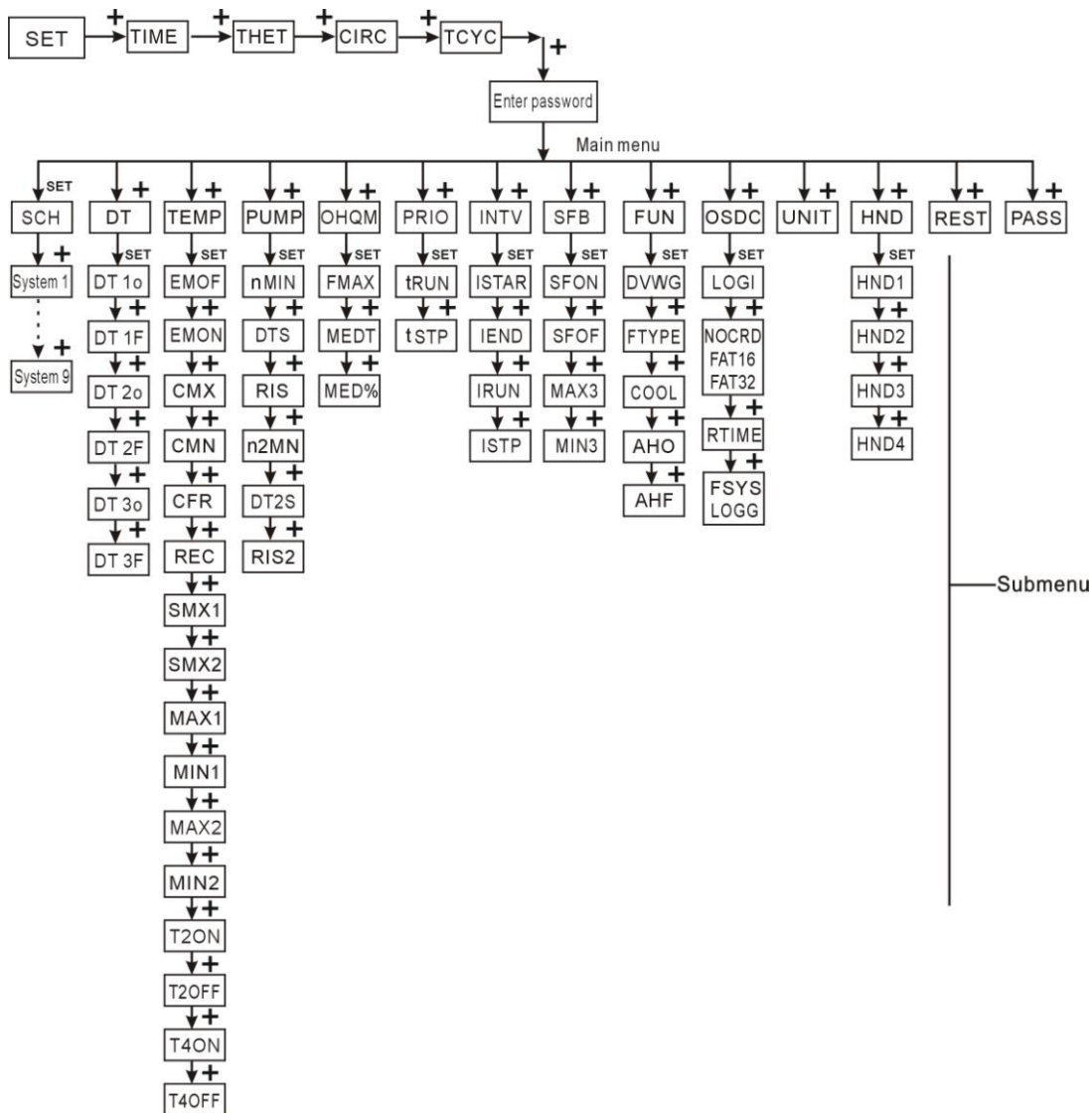

Submenu:

Through submenu, user can set the parameter as desired value, please check it carefully.

Note: since the selected solar system is different, and then menu details for the according system are different.

4.3 Menu description

| Code (Main menu) | Code (Submenu) | Menu Description |
|---------------------|-------------------|--|
| SCH | | For set desired system |
| DT | | For set the operation temperature difference |
| TEMP | | For set relevated temperatures |
| | EMOF | The maximum switch-off temperature of collector |
| | EMON | The maximum switch-on temperature of collector |
| | CMX | The maximum temperature of collector (Collector cooling function) |
| | CMN | Low temperature protection of collector |
| | CFR | Frost protection of collector |
| | REC | Tank recooling function |
| | SMX1 | The Maximum temperature of storage 1 |
| | SMX2 | The Maximum temperature of storage 2 |
| | SMAX5 | Sensor set of the maximum temperature of storage 2 |
| | MAX1 | The maximum switch off temperature (for heat transferring between storage and heating return) |
| | MIN1 | The minimum switch-on temperature (for heat transferring between storage and heating return) |
| | MAX2 | The maximum switch-off temperature (for heat transferring between heat exchanger and storage) |
| | MIN2 | The minimum switch-on temperature (for heat transferring between heat exchanger and storage) |
| | T2ON | The switch-on temperature of circuit pump for heat transferring from tank 1 to tank2 |
| | T2OFF | The switch-off temperature of circuit pump for heat transferring from tank 1 to tank2 |
| | T4ON | The switch-on temperature of circuit pump for heat transferring from tank 2 to tank1 |
| | T4OFF | The switch-off temperature of circuit pump for heat transferring from tank 2 to tank1 |
| PUMP | | For set the speed parameters of circuit pump |
| | nMIN | Speed adjust of circuit pump 1 (RPM control) |
| | DTS | Standard temperature difference of pump 1 (for speed adjust of circuit pump 1) |
| | RIS | Increase scale of pump 1 (for speed adjust of circuit pump 1) |
| | n2MN | Speed adjust of circuit pump 2 (RPM control) |
| | DT2S | Standard temperature difference of pump 2 (for speed adjust of circuit pump 2) |
| | RIS2 | Increase scale of pump 2 (for speed adjust of circuit pump 2) |
| OHQM | | For thermal energy measuring |
| | FMAX | Flow rate |
| | MEDT | Type of heat transfer liquid |
| | MED% | Concentration of heat transfer liquid |
| PRIO | | Storage priority heating |
| | tRUN | Pump running time |
| | tSTP | Pump interval time |
| INTV | | For timing function |
| | ISTAR | Switch-on time of timing function |
| | IEND | Switch-off time of timing function |
| | IRUN | Pump interval run-on time |

| | | |
|------|-------|--|
| | ISTP | Pump interval run-off time |
| SFB | | For turn on/off the solid fuel boiler |
| | SFON | The minimum turn-on temperature of storage |
| | SFOF | The maximum turn-off temperature of storage |
| | MAX3 | The maximum temperature for switch-off solid fuel boiler |
| | MIN3 | The minimum temperature for switch-on solid fuel boiler |
| FUN | | Auxiliary functions |
| | DVWG | Anti legionnaires' function |
| | FTYPE | Flow counter type selection |
| | COOL | High temperature cooling |
| | AHO | The switch-on temperature of auto thermostat |
| | AHF | The switch-off temperature of auto thermostat |
| OSDC | | SD card function |
| | LOGI | Data save interval (in minute) |
| | NOCRD | No card in groove |
| | FAT16 | Memory < 2G |
| | FAT32 | Memory > 2G |
| | RTIME | left time available for saving data (in day) |
| | FSYS | Error on system files |
| | LOGG | Possible to log |
| UNIT | | Celsius and Fahrenheit temperature switch |
| HDN | | Manual controlling |
| REST | | Recovery to factory set |
| PASS | | Password set |

4.4 System overview

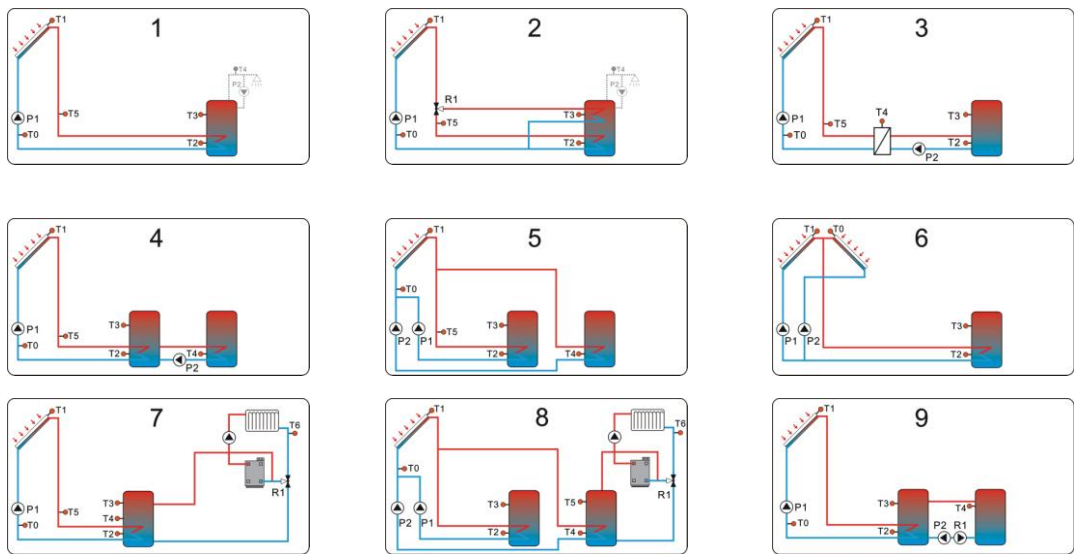

4.5 System description

Note: storage temperature sensor T3, T5 are optional sensor, if these 2 sensors are not installed on the upper part of the storage, controller will adopt the temperature signal from sensors T2, T4 installed on the bottom part of storage to control back-up heater or circuit pump.

SCH 1 (Standard solar system, 1 Storage)

System description:

Controller compares the temperature between collector T1 and storage T2 (bottom part), if the temperature difference (DT) rises up to the preset switch-on ($\Delta T1$) or is over it, circuit pump P1 is triggered, and then storage is heated until DT drops to the switch-off DT or when the storage temperature rises up to its preset maximum temperature. Then circuit pump P1 is ceased.

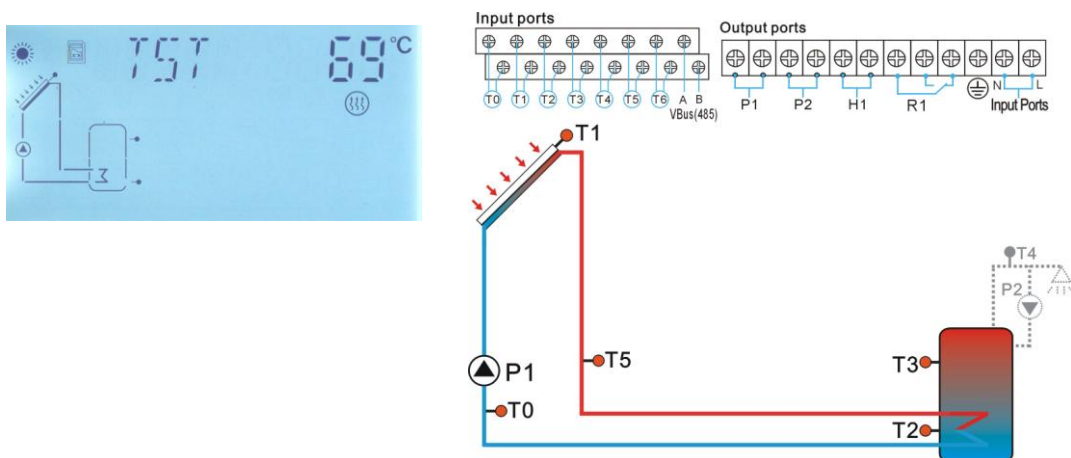

| Sensor | Description | Output relay | Description |
|--------|--|--------------|--------------------------|
| T0 | Sensor for thermal energy measuring (optional) | P1 | For solar circuit pump 1 |
| T1 | Sensor on the collector | P2 | - |
| T2 | Sensor on the bottom part of storage | H1 | For back-up heater |
| T3 | Sensor on the upper part of storage (optional) | R1 | - |
| T4 | - | | |
| T5 | Sensor on the hot water return pipe (Optional) | | |
| T6 | - | | |

The auxiliary functions available in this system (available functions)

| Sensor | Description | Output relay | Description |
|--------|--|--------------|--|
| T4 | <ul style="list-style-type: none"> ➤ For measuring the hot water temperature ➤ For measuring the temperature of solid fuel boiler ➤ For auto thermostat | P2 | Available for: <ul style="list-style-type: none"> ➤ DHW pump ➤ Circuit pump for solid fuel boiler ➤ (AHO) auto thermostat |
| T3 | | R1 | <ul style="list-style-type: none"> ➤ For (COOL) high temperature cooling |

Above mentioned auxiliary functions need to be activated in menu.

SCH 2 (1 Storage, T - valve layer heating)

System description:

Controller compares the temperature between collector T1 and storage T2($\Delta T1$)、T3($\Delta T2$), if the temperature difference (DT) rises up to the preset switch-on DT or is over it, circuit pump P1 is triggered, and simultaneously, T-Valve R1 switches to the according part, and this part of the storage is heated until DT drops to the switch-off DT or when the storage temperature rises up to its preset maximum temperature. Then circuit pump P1 is ceased. Priority logic determines to heat the bottom part of storage prior.

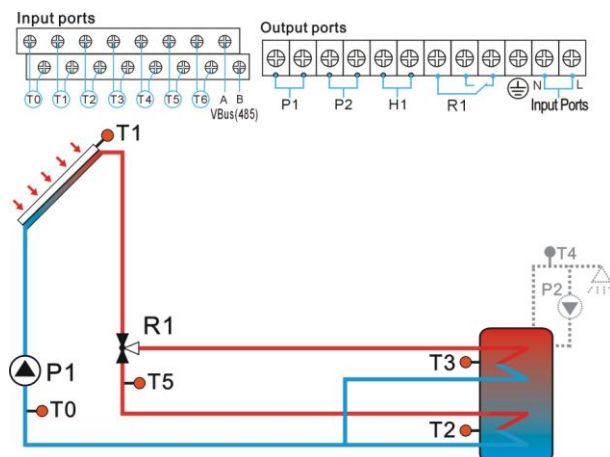
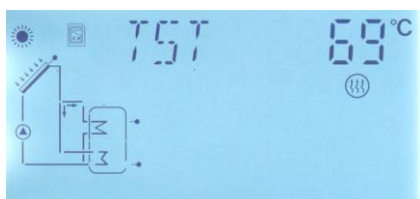

| Sensor | Description | Output relay | Description |
|--------|--|--------------|------------------------------------|
| T0 | Sensor for thermal energy measuring (optional) | P1 | For solar circuit pump 1 |
| T1 | Sensor on the collector | P2 | - |
| T2 | Sensor on the bottom part of storage | H1 | For back-up heater |
| T3 | Sensor on the upper part of storage (optional) | R1 | For T-valve to switch to heat tank |
| T4 | - | | |
| T5 | Sensor on the hot water return pipe (optional) | | |
| T6 | - | | |

The auxiliary functions available in this system (available functions)

| Sensor | Description | Output relay | Description |
|--------|--|--------------|--|
| T4 | <ul style="list-style-type: none"> ➤ For measuring the hot water temperature ➤ For measuring the temperature of solid fuel boiler ➤ For auto thermostat | P2 | Available for: <ul style="list-style-type: none"> ➤ DHW pump ➤ Circuit pump for solid fuel boiler ➤ (AHO) auto thermostat |
| T3 | | R1 | |

Above mentioned auxiliary functions need to be activated in menu.

SCH 3 (Standard system, heat exchanger control logic)

System description:

Controller compares the temperature between collector T1 and storage T2 ($\Delta T1$), if the temperature difference (DT) rises up to the preset switch-on DT or is over it, then correspondingly, circuit pump P1 is triggered, and the heat exchanger is heated until DT drops to the switch-off DT or when the heat exchanger temperature rises up to its preset maximum temperature. Then circuit pump P1 is ceased.

Use another temperature difference between T4, T2 ($\Delta T1$) to control pump P2 can heat the storage.

Note: If T4 isn't installed, then when DT between collector T1 and storage T2 rises up to or exceeds the switch-on DT, circuit pump P1, P2 will be triggered at the same time, and they will keep running until DT drops to the switch-off DT or when the storage temperature rises up to its preset maximum temperature, then both pumps are stopped.

See detailed operation at 6.3.11 & 6.3.12

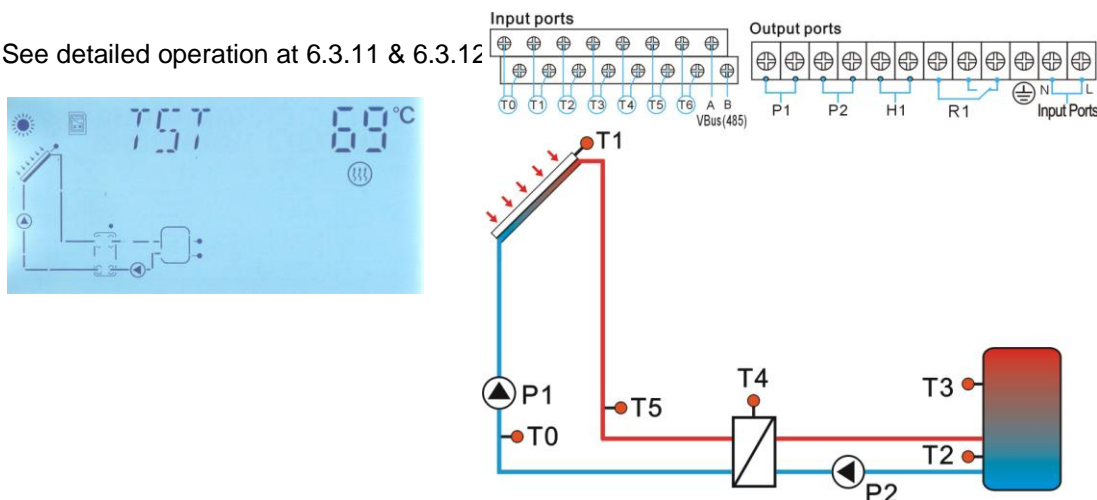

| Sensor | Description | Output relay | Description |
|--------|--|--------------|------------------------------------|
| T0 | Sensor for thermal energy measuring (optional) | P1 | For solar circuit pump 1 |
| T1 | Sensor on the collector | P2 | For heat transferring circuit pump |
| T2 | Sensor on the bottom part of storage | H1 | For back-up heater |
| T3 | Sensor on the upper part of storage (optional) | R1 | |
| T4 | Sensor on the heat exchanger | | |
| T5 | Sensor on the hot water return pipe (optional) | | |
| T6 | - | | |

The auxiliary functions available in this system (available functions)

| Sensor | Description | Output relay | Description |
|--------|-------------|--------------|-------------------------------------|
| T3 | | R1 | For (COOL) high temperature cooling |

Above mentioned auxiliary functions need to be activated in menu.

SCH 4 (2 Storages, heat transferring control logic)

System description:

Controller compares the temperature between collector T1 and storage T2($\Delta T1$), if the temperature difference (DT) rises up to or exceeds the preset switch-on DT, the circuit pump P1 is triggered, and storage is heated until DT drops to the switch-off DT or when the storage temperature rises up to its preset maximum temperature. Then circuit pump P1 is ceased.

Use another temperature difference between T3, T4 ($\Delta T2$) to control pump P2 can transfer thermal energy from storage 1 to storage 2. See detailed operation at 6.3.9 & 6.3.10.

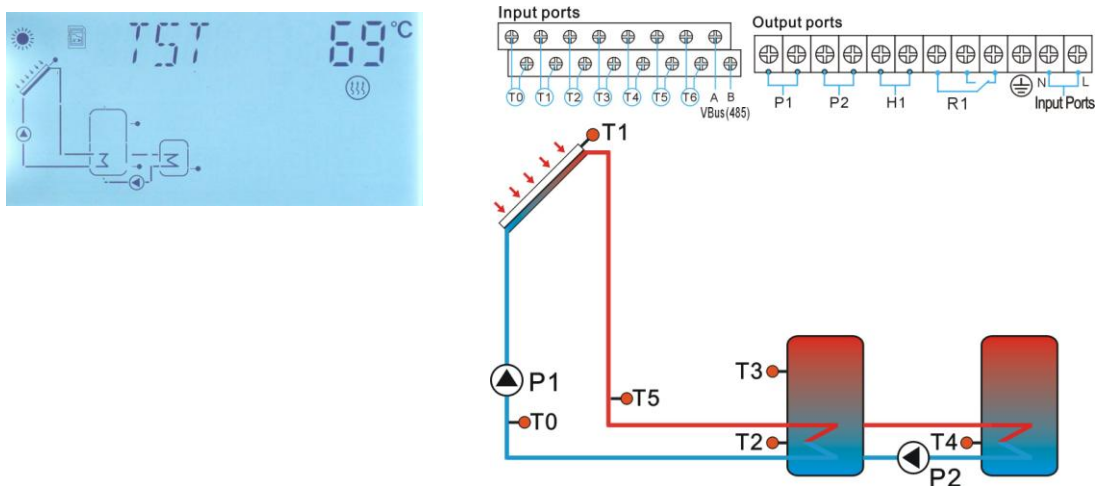

| Sensor | Description | Output relay | Description |
|--------|---|--------------|------------------------------------|
| T0 | Sensor for thermal energy measuring (optional) | P1 | For solar circuit pump 1 |
| T1 | Sensor on the collector | P2 | For heat transferring circuit pump |
| T2 | Sensor on the bottom part of storage1 | H1 | For back-up heater |
| T3 | Sensor on the upper part of storage 1(optional) | R1 | |
| T4 | Sensor on the storage 2 | | |
| T5 | Sensor on the hot water return pipe (optional) | | |
| T6 | - | | |

The auxiliary functions available in this system (available functions)

| Sensor | Description | Output relay | Description |
|--------|-------------|--------------|-------------------------------------|
| T3 | | R1 | For (COOL) high temperature cooling |

Above mentioned auxiliary functions need to be activated in menu.

SCH 5 (2 Storages, Pump control logic)

System description:

Controller compares the temperature between collector T1 and storage T2(ΔT_1), T4 (ΔT_2) , if any of 2 temperature difference (DT) rises up to or exceeds its preset switch-on DT, then the corresponding circuit pump P1 / P2 is triggered , and storage is heated until DT drops to the switch-off DT or when the storage temperature rises up to its preset maximum temperature. Then circuit pump P1/P2 is ceased. Priority logic determines to heat the storage 1 prior.

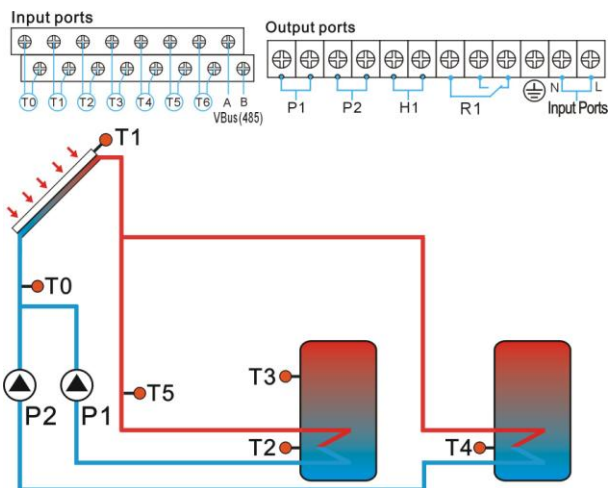
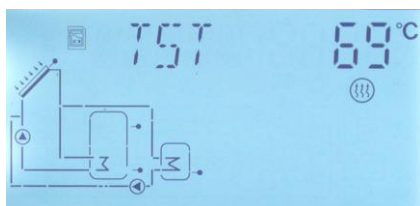

| Sensor | Description | Output relay | Description |
|--------|---|--------------|--------------------------|
| T0 | Sensor for thermal energy measuring (optional) | P1 | For solar circuit pump 1 |
| T1 | Sensor on the collector | P2 | For solar circuit pump 2 |
| T2 | Sensor on the bottom part of storage 1 | H1 | For back-up heater |
| T3 | Sensor on the upper part of storage 1(optional) | R1 | |
| T4 | Sensor on the storage 2 | | |
| T5 | Sensor on the hot water return pipe (optional) | | |
| T6 | - | | |

The auxiliary functions available in this system (available functions)

| Sensor | Description | Output relay | Description |
|--------|-------------|--------------|-------------------------------------|
| T3 | | R1 | For (COOL) high temperature cooling |

Above mentioned auxiliary functions need to be activated in menu.

SCH 6 (East/west collectors, 1 storage)

System description:

Controller compares the temperature between collector T1, T0 and storage T2($\Delta T1$), if any of 2 temperature difference (DT) rises up to or exceeds its preset switch-on DT, then 2 corresponding circuit pump P1,P2 are triggered, and the storage is heated until DT drops to the switch-off DT or when the storage temperature rises up to its preset maximum temperature. Then circuit pumps P1, P2 are ceased.

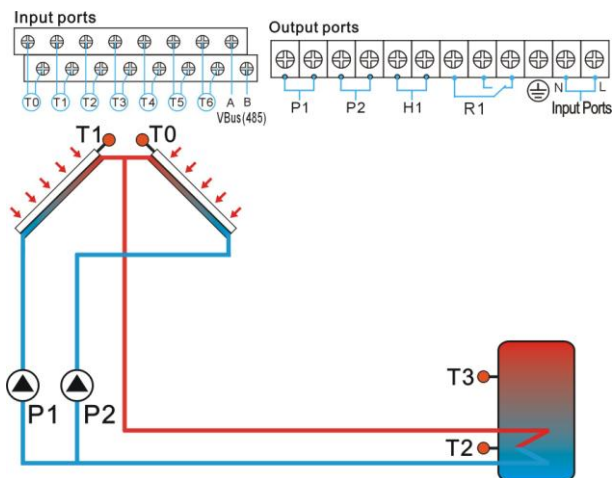
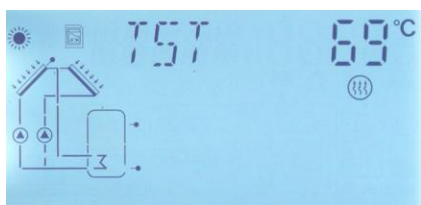

| Sensor | Description | Output relay | Description |
|--------|--------------------------------------|--------------|--------------------------|
| T0 | Sensor on west collector | P1 | For solar circuit pump 1 |
| T1 | Sensor on east collector | P2 | For solar circuit pump 2 |
| T2 | Sensor on the bottom part of storage | H1 | For back-up heater |
| T3 | Sensor on the upper part of storage | R1 | |
| T4 | | | |
| T5 | | | |
| T6 | - | | |

The auxiliary functions available in this system (available functions)

| Sensor | Description | Output relay | Description |
|--------|-------------|--------------|-------------------------------------|
| T3 | | R1 | For (COOL) high temperature cooling |

Above mentioned auxiliary functions need to be activated in menu.

SCH 7 (1 storages , Heating-return control logic)

System description:

Controller compares the temperature between collector T1 and storage T2($\Delta T1$), if the temperature difference (DT) rises up to or exceeds its preset switch-on DT, then the circuit pump P1 is triggered , the storage is heated until DT drops to the switch-off DT or when the storage temperature rises up to its preset maximum temperature. Then circuit pumps P1 is ceased.

Another temperature difference T4, T6 ($\Delta T2$) to control R1, it can heat heating-return.

Note: if T4 isn't installed, then DT between T3, T6 ($\Delta T2$) to control R1 to heat heating-return.

If T3, T4 both aren't installed, the DT between T2, T6 ($\Delta T2$) to control R1 to heat heating-return.

See detailed operation at 6.3.9 & 6.3.10

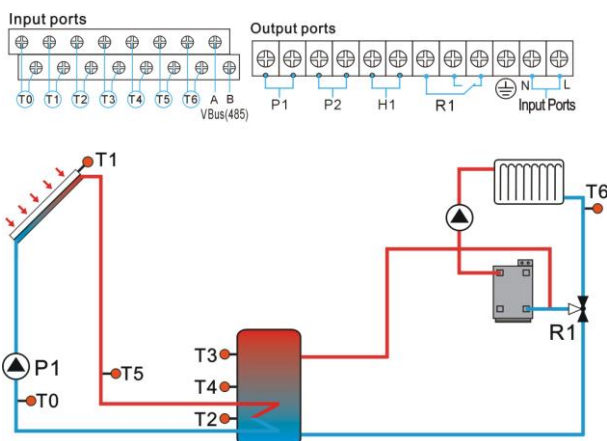
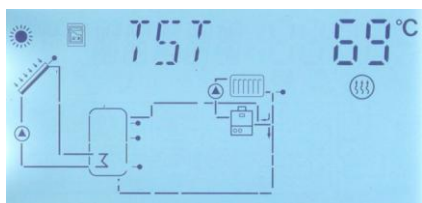

| Sensor | Description | Output relay | Description |
|--------|---|--------------|---------------------------------------|
| T0 | Sensor for thermal energy measuring (optional) | P1 | For solar circuit pump 1 |
| T1 | Sensor on the collector | P2 | |
| T2 | Sensor on the bottom part of storage | H1 | For back-up heater |
| T3 | Sensor on the upper part of storage (optional) | R1 | T-Valve switch to heat heating return |
| T4 | Sensor on the middle part of storage (optional) | | |
| T5 | Sensor on the hot water return pipe (optional) | | |
| T6 | Sensor on floor heating | | |

SCH 8 (2 storages, Heating-return control logic)

System description:

Controller compares the temperature between collector T1 and storage T2($\Delta T1$), T4($\Delta T2$), if the temperature difference (DT) rises up to or exceeds its preset switch-on DT, then the corresponding circuit pump P1/P2 is triggered to heat storage until DT drops to the switch-off DT or when the storage temperature rises up to its preset maximum temperature. Then circuit pump P1/P2 is ceased. Priority logic determines to heat storage 1 prior.

Another temperature difference T5, T6 ($\Delta T3$) to control R1, it can heat heating-return.

Note: if T5 isn't installed, then DT between T4, T6 ($\Delta T3$) to control R1 to heat heating-return. See detailed operation at 6.3.9 & 6.3.10

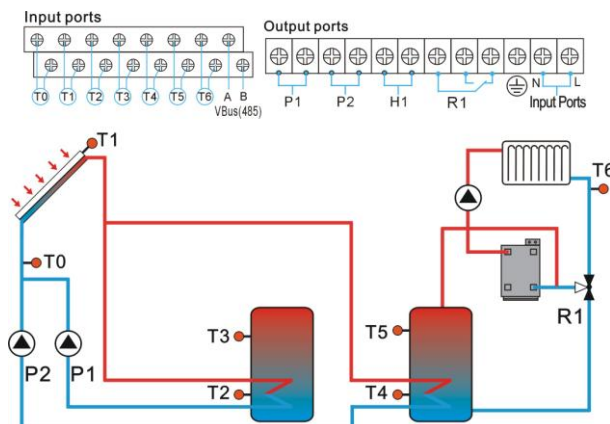
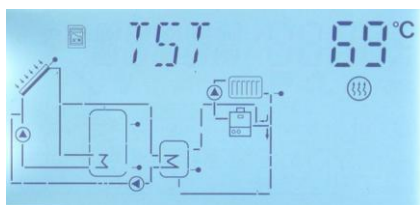

| Sensor | Description | Output relay | Description |
|--------|---|--------------|---------------------------------------|
| T0 | Sensor for thermal energy measuring (optional) | P1 | For solar circuit pump 1 |
| T1 | Sensor on the collector | P2 | For solar circuit pump 2 |
| T2 | Sensor on the bottom part of storage 1 | H1 | For back-up heater |
| T3 | Sensor on the upper part of storage 1(optional) | R1 | T-Valve switch to heat heating return |
| T4 | Sensor on the bottom part of storage 2 | | |
| T5 | Sensor on the upper part of storage 2(optional) | | |
| T6 | Sensor on floor heating | | |

SCH 9 (2 storages, Heat inter-transferring control logic)

System description:

Controller compares the temperature between collector T1 and storage T2($\Delta T1$), if the temperature difference (DT) rises up to or exceeds its preset switch-on DT, then the corresponding circuit pump P1 is triggered to heat storage until DT drops to the switch-off DT or when the storage temperature rises up to its preset maximum temperature. Then circuit pump P1 is ceased.

See detailed operation at 6.3.13 & 6.3.16

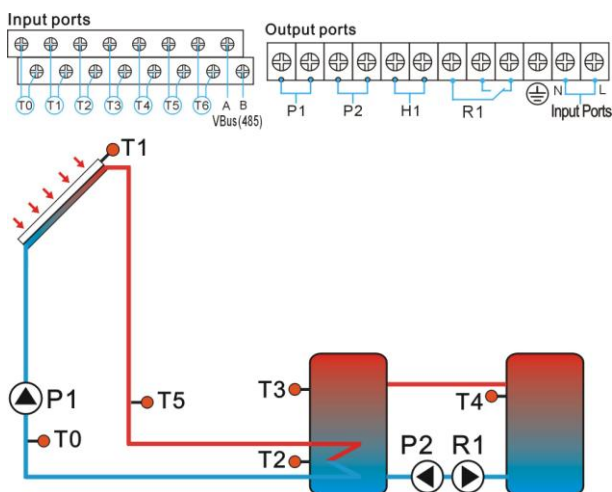
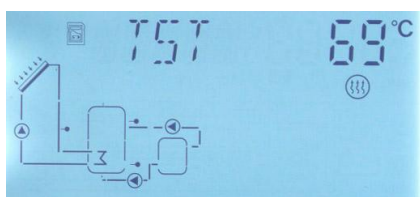

| Sensor | Description | Output relay | Description |
|--------|---|--------------|--|
| T0 | Sensor for thermal energy measuring (optional) | P1 | For solar circuit pump 1 |
| T1 | Sensor on the collector | P2 | For heat transferring pump from tank 1 to tank 2 |
| T2 | Sensor on the bottom part of storage 1 | H1 | For back-up heater |
| T3 | Sensor on the upper part of storage 1(optional) | R1 | For heat transferring pump from tank 2 to tank 1 |
| T4 | Sensor on the bottom part of storage 2 | | |
| T5 | Sensor on the heat return pipe (optional) | | |
| T6 | | | |

5. Function operation and parameter setup (user grade)

5.1 Set time/week

- ▶ Press “SET” button, “Time” displays on the screen,
- ▶ Repress “SET” button, hour selection area “00” blinks on the display screen.
- ▶ Press “+” “-” button to set hour of clock
- ▶ Press “SET” button again; minute area “00” blinks
- ▶ Press “+” “-” button to set minute of clock.
- ▶ Press “SET” again, week area “MO” blinks
- ▶ Press “+” “-” button to set week.
- ▶ Press “SET” again, “DAY/MONTH/YEAR” area “Year” blinks
- ▶ Press “+” “-” button to set year.
- ▶ Press “SET” again, “Month” blinks
- ▶ Press “+” “-” button to set month.
- ▶ Press “SET” again, “DAY” blinks
- ▶ Press “+” “-” button to set day.
- ▶ Press “ESC” button to exit set program, or wait for 20 seconds to exit program automatically. The set parameter values of time and week are saved automatically,



| Code | Meaning |
|------|-----------|
| MO | Monday |
| TU | Tuesday |
| WE | Wednesday |
| TH | Thursday |
| FR | Friday |
| SA | Saturday |
| SU | Sunday |

5.2 THET Timing Heating

Description:

Electrical heater, gas boiler or oil boiler can be integrated into solar system used as back-up of system, and they can be triggered automatically at preset schedule by preset temperature. Within a preset schedule, when the temperature (T3) of top part of tank drops below the preset switching-on temperature of this function, back-up heating starts to work, when T3 rises up to the preset turning off temperature, back-up heating is stopped. Within 24 hours, three time sections can be set with this controller.

Factory set:

The first schedule: back-up heating function starts at 4:00 and ends at 5:00 am. Within this time section, default switch-on temperature is 40°C; default switch-off temperature is 45°C.

The second schedule: starts at 10:00 and ends also at 10:00 am, it means no back-up heating in this time.

The third schedule: back-up heating function starts at 17:00 and ends at 22:00 pm. Within this time section, default switch-on temperature is 50°C; default switch-off temperature is 55°C.

The switch-on temperature adjustable range: 10 °C ~ (OFF-2 °C)

The switch-off temperature adjustable range: (ON+2 °C) ~ 80 °C

If you want to shut off one timing heating, then you can set the turning on time and turning off time with a same value (for example, the second time section no this function, then you can set turning on/off time is 10:00 ~ 10:00)

When time is outside of the preset schedule, back-up heating doesn't work automatically even when the tank temperature drops to the switch –on temperature of heating.

Note:

- When there is no sensor installed in the top part of tank (no T3 sensor), controller will take the signal of T2 (sensor in bottom of tank) automatically to control this function.
- The time in this controller is 24 hours model, when you set schedule, the switch-off time of heating should be larger than switch-on time. For example: if you set the switch-on time of heating is at 17:00, but switch-off time of heating is 6:00, then this setting doesn't take effect, that means within this time section, heating function doesn't work. The correct set is like flowing: it should be divided into two time sections, one time section is from 17:00 to 23:59, the other time section is from 00:00 to 06:00.

Setup steps: under standby,

▶ Press "SET" button, "tHET" displays on the screen.

▶ Repress "SET" button to access "tHET" program menu.

▶ Repress "SET" button again, to set parameters of "tHET", "tH 1o 04:00" displays on the



screen, "04" of hour time blinks on screen, the switch-on time and temperature for the first schedule of heating function can be set.

▶ Press "+" "-" button to adjust hour of time.

▶ Repress "SET" button again, "00" of minute time blinks on screen.

▶ Press "+" "-" button to adjust minute of time.

▶ Repress "SET" button, temperature "40°C" blinks on screen.

▶ Press "+" "-" button, to set the switch-on temperature of heating.

▶ Then, press "ESC" to exit this submenu.



▶ Press "+" button, "tH 1F 05:00" displays on the screen, to access the submenu of the switch-off time and temperature for the first schedule of heating function.

▶ Press "SET" button again, "05" of hour time blinks on screen.



▶ Press "+" "-" button to adjust hour of time.

▶ Repress "SET" button again, "00" of minute time blinks on screen.

▶ Press "+" "-" button to adjust minute of time.

▶ Repress "SET" button, temperature "45°C" blinks on screen.

▶ Press "+" "-" button, to set the switch-off temperature of heating.

▶ Then, press "ESC" to exit this submenu, or wait for 20 seconds to exit automatically, the parameter valves are saved automatically.

▶ Press "+" button, "tH 2o 10:00" displays on the screen, to access the submenu of the switch-on time and temperature for the second schedule of heating function.

▶ Press "SET" button again, "10" of hour time blinks on screen.



▶ Press "+" "-" button to adjust hour of time.

▶ Repress "SET" button again, "00" of minute time blinks on screen.

- ▶ Press “+” “-” button to adjust minute of time.
- ▶ Repress “SET” button, temperature “50°C” blinks on screen.
- ▶ Press “+” “-” button, to set the switch-on temperature of heating.
- ▶ Then, press “ESC” to exit this submenu.
- ▶ Press “+” button, “tH 2F 10:00” displays on the screen, to access the submenu of the switch-off time and temperature for the second schedule of heating function.

▶ Press “SET” button again, “10” of hour time blinks on screen.

▶ Press “+” “-” button to adjust hour of time.

▶ Repress “SET” button again, “00” of minute time blinks on screen.



▶ Press “+” “-” button to adjust minute of time.

▶ Repress “SET” button, temperature “55°C” blinks on screen.

▶ Press “+” “-” button, to set the switch-off temperature of heating.

▶ Then, press “ESC” to exit this submenu, or wait for 20 seconds to exit automatically, the parameter valves are saved automatically.

▶ Press “+” button, “tH 3o 17:00” displays on the screen, to access the submenu of the switch-on time and temperature for the third schedule of heating function.

▶ Press “SET” button again, “17” of hour time blinks on screen.

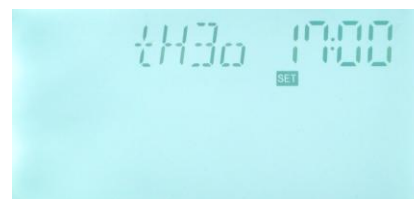

▶ Press “+” “-” button to adjust hour of time.

▶ Repress “SET” button again, “00” of minute time blinks on screen.

▶ Press “+” “-” button to adjust minute of time.

▶ Repress “SET” button, temperature “50°C” blinks on screen.

▶ Press “+” “-” button, to set the switch-on temperature of heating.

▶ Then, press “ESC” to exit this submenu.

▶ Press “+” button, “tH 3F 22:00” displays on the screen, to access the submenu of the switch-off time and temperature for the third schedule of heating function.

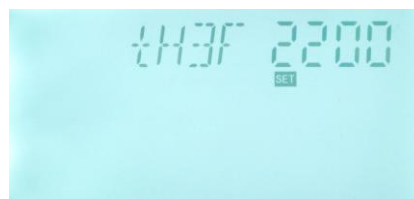

- ▶ Press “SET” button again, “22” of hour time blinks on screen.
- ▶ Press “+” “-” button to adjust hour of time.
- ▶ Repress “SET” button again, “00” of minute time blinks on screen.
- ▶ Press “+” “-” button to adjust minute of time.
- ▶ Repress “SET” button, temperature “55°C” blinks on screen.
- ▶ Press “+” “-” button, to set the switch-off temperature of heating.
- ▶ Then, press “ESC” to exit this submenu, or wait for 20 seconds to exit automatically, the parameter valves are saved automatically.

Note: when no gas or oil boiler is connected to solar system, electrical heater can be installed as back-up device, when electrical heater is in operation status, signal  blinks on screen, and LED light is on.

Application sample:

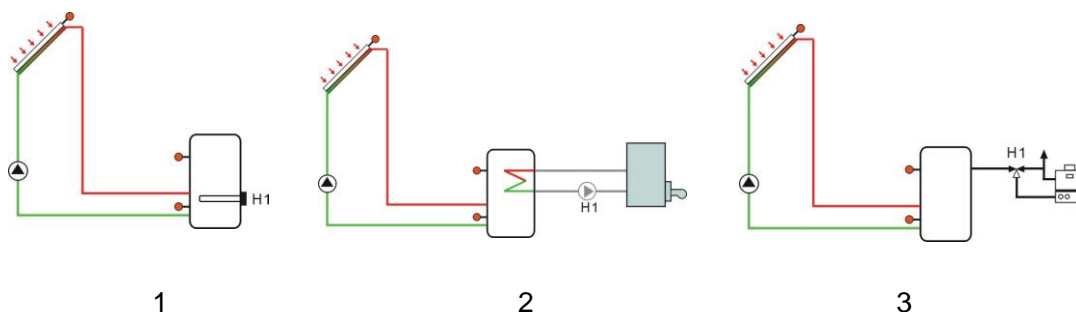

If customer uses electrical heater as back-up, please according to the power of electrical heater to equip corresponding safety devices like contactor and breaker with this controller, we strongly recommend equipping with SR802 device with this controller, (SR802 detailed technical data see paragraph spare parts)

5.3 CIRC DHW pump control function

Select CIRC submenu, “CIRF OFF” appears on the screen, the default set is: OFF.



- ▶ Press “SET” button, parameter “OFF” blinks on the screen.
- ▶ Press “SET” button again to activate this function, “CIRC ON” appears on the screen.

▶ Press “ESC” to exit this submenu, or wait for 20 seconds to exit automatically, the parameter valves are saved automatically.

▶ Press “+” button, “tCYC” appears on the screen.



▶ Press “SET” button to access “tCYC” menu.

▶ Press “SET” button, access tCYC three schedules function, “tC 1o 05:00” appears, now can set the first turn-on time.



▶ Press “SET” button again, “05” of hour time blinks on screen.

▶ Press “+” “-” button to adjust hour of time.



▶ Repress “SET” button again, “00” of minute time blinks on screen.

▶ Press “+” “-” button to adjust minute of time.



▶ Repress “SET” button, temperature “03 Min” blinks on screen.

▶ Press “+” “-” button, to set the running time of DHW circuit pump.

▶ Press “ESC” to exit this submenu.

▶ Press “+” button, “tC 1F 07:00” displays on the screen, to access the menu to set the first turn-off time of DHW pump.



▶ Press “SET” button, “07” of hour time blinks on screen.

▶ Press “+” “-” button to adjust hour.

▶ Press “SET” button, “00” of minute time blinks on the screen.



▶ Press “+” “-” button to adjust minute of time.

▶ Repress “SET” button, “15 Min” blinks on the screen.

▶ Press “+” “-” button to adjust interval time of DHW pump.

▶ Then, press “ESC” to exit this submenu, or wait for 20 seconds to exit automatically, the parameter values are saved automatically.

▶ Press “+” button, access the second schedule set, “tC 2o 11:00” appears, now can set the second turn-on time.

▶ Press “SET” button again, “11” of hour time blinks on screen.



▶ Press “+” “-” button to adjust hour of time.

▶ Re-press “SET” button again, “00” of minute time blinks on screen.



▶ Press “+” “-” button to adjust minute of time.

▶ Re-press “SET” button, temperature “03 Min” blinks on screen.

▶ Press “+” “-” button, to set the running time of DHW circuit pump.

▶ Press “ESC” to exit this submenu.

▶ Press “+” button, “tC 2F 13:00” displays on the screen, to access the menu to set the second turn-off time of DHW pump.



▶ Press “SET” button, “13” of hour time blinks on screen.

▶ Press “+” “-” button to adjust hour.

▶ Press “SET” button, “00” of minute time blinks on the screen.



▶ Press “+” “-” button to adjust minute of time.

▶ Re-press “SET” button, “15 Min” blinks on the screen.

▶ Press “+” “-” button to adjust interval time of DHW pump.

▶ Then, press “ESC” to exit this submenu, or wait for 20 seconds to exit automatically, the parameter valves are saved automatically.

 ▶ Press “+” button, access the third schedule set, “tC 3o 17:00” appears, now can set the third turn-on time.

▶ Press “SET” button again, “17” of hour time blinks on screen.



▶ Press “+” “-” button to adjust hour of time.

▶ Re-press “SET” button again, “00” of minute time blinks on screen.



▶ Press “+” “-” button to adjust minute of time.

▶ Re-press “SET” button, temperature “03 Min” blinks on screen.

▶ Press “+” “-” button, to set the running time of DHW circuit pump.

▶ Press “ESC” to exit this submenu.

▶ Press “+” button, “tC 3F 22:00” displays on the screen, to access the menu to set the third turn-off time of DHW pump.



▶ Press “SET” button, “13” of hour time blinks on screen.

▶ Press “+” “-” button to adjust hour.

▶ Press “SET” button, “00” of minute time blinks on the screen.

▶ Press “+” “-” button to adjust minute of time.



▶ Re-press “SET” button, “15 Min” blinks on the screen.

▶ Press “+” “-” button to adjust interval time of DHW pump.

▶ Then, press “ESC” to exit this submenu, or wait for 20 seconds to exit automatically, the parameter valves are saved automatically.

Description of temperature controlled DHW pump:

Solar system can provide temperature-controlled hot water circulation function; this function needs an extra hot water circulation pump (connect output port P2) and a sensor, which is installed on the return pipe of hot water (connect input port T4). When the temperature signal of sensor T4 is less than the preset turning on temperature of DHW pump, the hot water circulation pump (P2) triggers and works till the temperature exceeds the turning off temperature.

Condition for triggering hot water circulation pump: only when tank temperature T3 is 2°C higher than the required hot water temperature, hot water circulation pump just can be triggered.

Description of time controlled DHW pump:

DHW pump can also be controlled at the preset time sections, this function needs an extra DHW pump (connect output port P2), this pump will be timing triggered, and within a running time section, default operation is pump runs for 3 minutes, then stops for 15 minutes, the process repeats within the time section.

Default time sections:

The first time section: pump works at 05:00 and stops at 07:00.

The second time section: pump works at 11:00 and stops at 13:00.

The third time section: pump works at 17:00 and stops at 22:00.

If user wants to switch-off any time section, then just set the start time and close time with same time.e.g starts at 05:00 and close also at 05:00.

Note:

- Temperature controlled DHW function is prior to time controlled DHW.
- When T4 is installed on the return pipe of hot water, controller will automatically turn-off the time controlled function, inverse to use temperature control DHW.
- In order to avoid large measuring error, the sensor T4 on hot water return pipe should be installed 1.5m far away from tank. This function isn't available in all systems.

6. function operation and parameter setup (engineer grade)

6.1 Access main menu

Under standby, doing like following to access main menu.

▶ Press “SET” button, then press “+” button until “PWD 0000” appears on the screen, then repress “SET” button, the left first digital blinks, ask for entering password, factory default set password is “0000”



▶ Press “+” “-” button to enter first digital of password.

▶ Repress “SET” button, the second digital blinks

▶ Repress “+” “-” button, to enter second digital of password.

▶ Repeat press “SET” button, the third digital blinks

▶ Repress “+” “-” button, to enter third digital of password.

▶ Repeat press “SET” button, the forth digital blinks

▶ Repress “+” “-” button, to enter forth digital of password.

▶ Repress “SET” button, to access the main menu.

▶ Press “+” “-” button, select any menu you wanted.

▶ Press “ESC” button, you can exit main menu.

Note: default factory set password is “0000”, if you don’t set new password, just press “SET” four times, then you can access main menu interface

6.2 DT Temperature difference

Description:

Solar circuit pump P1/P2 is triggered by the temperature difference function, so long as the temperature difference between collector and storage reaches the switch-on DT, solar circuit pump is triggered.

For example: the switch-on DT is 8°C, switch-off DT is 4°C, if the temperature on the bottom part of storage is 20°C, then just when collector temperature rises up to 28°C, pump is triggered, and when collector temperature drops to 24°C, pump is ceased.

Note: the switch-on/off DT of 8°C and 4°C are standard system setting according to many years’ experience, only in special application cases it needs to be changed, (e.g. far distance heat transferring), normally we recommend using default set. Switch-on and switch-off DT are

alternating set. To avoid mistake the minimum difference between two temperature differences ($\Delta T_{on} - \Delta T_{off}$) is set as 2 °C.

Setup temperature difference:

Under standby, following steps descript in paragraph 6.1 to access main menu DT

▶ Press “SET” button, to access settings program of main menu DT, “DT 1o 08 °C” displays on screen, “08 °C” blinks, the first switch-on temperature difference can be set.

▶ Press “+” “-” button, to adjust the value of switch-on DT, adjustable range (OFF+2 °C) ~20 °C, factory setting is 8 °C



▶ Press “ESC” button to exit this setting, parameter is saved automatically.

▶ Press “+” button, “DT 1F 04 °C” displays on screen, the first switch-off temperature difference can be set.



▶ Press “SET” button, “04 °C” blinks

▶ Press “+” “-” button to adjust the value of switch-off DT, adjustable range 0 °C~ (ON-2 °C) , factory set is 4 °C.

▶ Press “ESC” to exit menu, or wait for 20 seconds to exit automatically, the setup parameters are saved automatically.

Note: As every system is different to each other, maximum 3 sets temperature difference (DT1o, DT1F) (DT2o, DT2F) (DT3o, DT3F) can be set, setting steps are same like above description.

6.3 TEMP Temperature

For every system, the factory set parameters are for the best operation condition, which is fully integrated into the entire solar system. But these parameters can also be set individually to cater the special requirements, please carefully observe the operation data of system components after setting.

Note:

1. Parameters that can be set rely on the selected system, not all the parameters can be adjusted in every solar system.
2. Because of different of system, the content of following submenus is also different.

Following submenu can be access though TEMP main menu.

| Tem. Code | Function of temperature | Adjustable range | Factory set | Function exit tem. | Paragraph |
|--------------|---|-------------------|-------------|--------------------|-----------|
| EMOF | Collector maximum switch-off temperature | (ON+3 °C)~ 200 °C | 130 °C | | 6.3.1 |
| EMON | Collector maximum switch-on temperature | 80 °C ~ (OF-3 °C) | 120 °C | | 6.3.2 |
| CMX | Maximum limited collector temperature (collector cooling function) | 70 °C ~190 °C | 110 °C | 107 °C | 6.3.3 |
| CMN | Low temperature protection of collector | 0 °C~90 °C | --- | | 6.3.4 |
| CFR | Frost protection of collector | -10 °C~10 °C | --- | | 6.3.5 |
| REC | Tank re-cooling function | | OFF | | 6.3.6 |
| SMX1 | Maximum temperature of tank 1 | 2 °C~95 °C | 60 °C | 58 °C | 6.3.7 |
| SMX2 | Maximum temperature of tank 2 | 2 °C~95 °C | 60 °C | 58 °C | 6.3.8 |
| MAX1 | Maximum switch-off temperature (for heat transferring between storage and heating loop) | (MIN1+2 °C)~95 °C | 60 °C | | 6.3.9 |
| MIN1 | Minimum switch-on temperature (for heat transferring between storage and heating loop) | 10 °C~(MAX1-2 °C) | 30 °C | | 6.3.10 |
| MAX2 | Maximum switch-off temperature (for heat transferring between storage and heat exchanger) | (MIN2+2 °C)~95 °C | 60 °C | | 6.3.11 |
| MIN2 | Minimum switch-on temperature (for heat transferring between storage and heat exchanger) | 10 °C~(MAX2-2 °C) | 30 °C | | 6.3.12 |
| T2ON | Switch-on temperature for pump transferring heat from storage 1 to storage 2 | 60 °C~90 °C | 80 °C | | 6.3.13 |
| T2OFF | Switch-off temperature for pump transferring heat from storage 1 to storage 2 | 0 °C~ON-2 °C | 60 °C | | 6.3.14 |
| T4ON | Switch-on temperature for pump transferring heat from storage 2 to storage 1 | 30 °C~60 °C | 60 °C | | 6.3.15 |
| T4OFF | Switch-off temperature for pump transferring heat from storage 2 to storage 1 | 0 °C~ON-2 °C | 40 °C | | 6.3.16 |

6.3.1 EMOF Collector maximum switch-off temperature (for collector emergency close function)

Function description:

When collector temperature rises up to this maximum switch-off limited temperature (EM), collector emergency function is activated, solar circulation pump is stopped in order to avoid the damage of system's other components caused by high temperature. The adjustable range of EMOF temperature is (ON+3 °C) ~200 °C, factory set is 130 °C. If the temperature of collector rises up to EMOF limited temperature, solar circuit pump is ceased, but when collector temperature drops to the collector maximum switch-on temperature EMON (factory set is 120°C) , solar circuit pump will be reset, and collector emergency close function is deactivated.

Setup steps:

To access main menu TEMP, then select submenu EMOF, "EMOF 130°C" displays on the screen



▶ Press "SET" button, parameter "130 °C" blinks.

▶ Press "+" "-" button, to adjust this maximum switch-off temperature, adjust range (ON+3 °C) ~200 °C, factory set is 130 °C

▶ Repress "SET" button to activate and deactivate this function, if deactivate the function, "EMOF - - -" displays on the screen.

▶ Press "ESC" button to exit menu or wait for 20 seconds to exit automatically, set parameters are saved automatically.

6.3.2 EMON Collector maximum switch-on temperature (for collector emergency close function)

Setup steps:

To access main menu TEMP, then select submenu EMON, "EMO 120°C" displays on screen

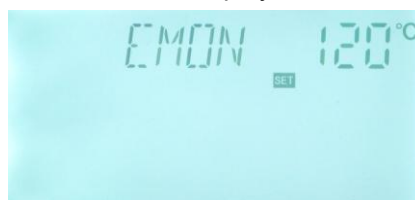

▶ Press "SET" button, parameter "120 °C" blinks.

▶ Press "+" "-" button, to adjust this maximum switch-on temperature, adjust range 80 °C ~ (OF-3 °C), factory set is 120 °C

► Repress “SET” button to activate and deactivate this function, if deactivate the function, “EMON - - -” displays on screen.

► Press “ESC” button to exit menu or wait for 20 seconds to exit automatically, set parameters are saved automatically.



When these two signals of EM blink on the screen, it indicates collector emergency close function is activated, and at this moment temperature of tanks reaches to its maximum limited temperature





When only this signal of EM blinks on the screen, it indicates collector emergency close function is also activated.(but temperature of tank doesn't reach to its maximum limited temperature)

6.3.3 CMX Maximum limited collector temperature (collector cooling function)

Function description:

If hot water in tank isn't used for long time, then the capacity that solar system absorbs solar irradiation reduces, when tank temperature rises to its preset maximal temperature, solar circuit pump is ceased compulsively even the temperature difference is satisfied. then when more solar irradiation shines in, as a result collector temperature will rise continuously, temperature of collector maybe rise up to the evaporated temperature of heat fluid, this phenomenon names collector - overheat, it should be avoided. Through set the Maximum limited collector temperature (collector cooling function) it can delay the vaporization of the heat transfer fluid. Shortly before reaching the maximum temperature of the collector, the solar pump starts working to cool down the heat transfer fluid using the heat losses occurring in pipelines and storage cylinder.

When collector temperature rises up to its maximal temperature, solar pump will be triggered again even at the case that tank temperature is already to its maximal temperature. And solar pump works until the temperature of collector drops because of this reversed circulation or when tank temperature rises its emergency temperature (95°C).

When  displays, and  blinks on the screen, it indicates that tank emergency temperature reaches, tank temperature is $\geq 95^{\circ}\text{C}$

Setup steps:

To access main menu TEMP, then select submenu CMX, “CMX 110 °C” displays on screen

▶ Press “SET” button, “110 °C” blinks.

▶ Press “+” “-” button to adjust collector limited maximum temperature ,adjust range : (70 °C~190 °C) , Factory set is 110 °C

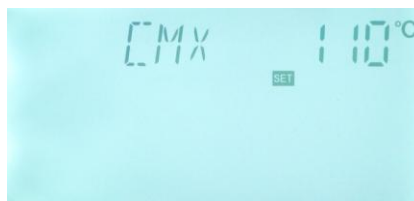

▶ Press “SET” button to activate and deactivate this function, if deactivate the function, “CMX - -” displays on screen.

▶ Press “ESC” button to exit menu or wait for 20 seconds to exit automatically, set parameters are saved automatically.

 CMX signal displays on screen, it indicates that collector cooling function is activated.

6.3.4 CMN low temperature protection of collector

Description:

When the actual temperature of collector is below the preset CMN temperature, solar circuit pump is ceased, even when the temperature difference between collector and storage exceeds switch-on temperature difference, solar pump doesn't work yet. When the temperature of collector is 3°C higher than the preset CMN temperature, solar circuit pump is standby to work, controller exits this program.

Setup steps:

To access main menu TEMP, then select submenu CMX, “CMN - - -” displays on screen, default set is OFF.

▶ Press “SET” button, default off signal “- - -” blinks on screen.

▶ Repress “SET” button to activate and deactivate this function.

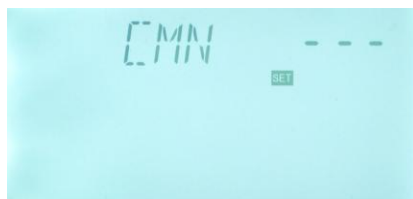

▶ Press “+” “-” button to adjust the low protection temperature of collector CMN, adjustable range (00 °C ~90 °C), after activate the function, factory set is 10 °C

▶ Press “ESC” button to exit the menu or wait for 20 seconds to exit automatically, parameters are saved automatically.



CMN signal displays on screen, it indicates that this function is activated.

6.3.5 CFR frost protection of collector

Description:

In winter when the temperature of collector is below the preset frost protection temperature (factory set is 4°C), solar circuit pump is triggered to transfer hot water from tank to collector and to heat collector by this reversed circuit. And when tank temperature (T2) drops to 6°C, electrical heater is triggered automatically and it keeps running until tank temperature T2 raises up to 21 °C or it is stopped when program of CFR is exited. When collector temperature rises up to 7 °C, solar circuit pump is ceased, program of CFR exits automatically.

This function is used in system, which uses water as heat transfer liquid, to avoid the freezing of solar heat transfer fluid.

Setup steps:

To access main menu TEMP, then select submenu CFR, “CFR ----” displays on screen, default set is off.

▶ Press “SET” button, default off “- - -” blinks.

▶ Repress “SET” button to activate or deactivate this function



▶ Press “+” “-” button to adjust the temperature of frost protection function, adjustable range is (-10 °C ~ 10 °C) , after function activated, default set is 4 °C

▶ Press “ESC” button to exit the menu or wait for 20 seconds to exit automatically, parameters are saved automatically.



CFR signal displays on screen, it indicates that this function is activated.

Note: this function is only available in special solar system which using no-anti-freezing liquid; this kind of system is only suitable in area where the ambient temperature is near to 0°C only for a few days. If safety requirement is very high, then anti-freezing is necessary, we suggest using suitable anti-freezing liquid to avoid frost problem.

6.3.6 REC Storage re-cooling function

Description:

If storage temperature rises up to its maximum temperature, and at the same time, collector temperature is 5°C lower than storage temperature, then solar pump can be triggered, through this reversed circulation, storage temperature is reduced by heat loss occurs in collector, solar pump keeps in working until storage temperature drops below its maximum temperature.

Setup steps:

To access main menu TEMP, then select submenu REC, "REC OFF" displays on screen, default set is off.

▶ Press "SET" button, parameter "OFF" blinks on screen

▶ Repress "SET" button to activate or deactivate this function; after function activated, factory set is "REC ON"

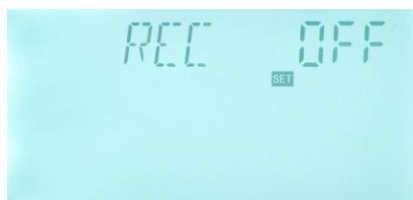

▶ Press "ESC" button to exit the menu or wait for 20 seconds to exit automatically, parameters are saved automatically.

☀ REC signal displays on screen, it indicates that this function is activated.

6.3.7 SMX1 Maximum temperature of tank 1

Description:

When the DT between collector T1 and tank 1 caters the switch-on DT of circulation, solar pump is triggered, but in order to avoid the high temperature inside tank, controller will check whether the temperature (T3) of the top part of tank is higher than the maximum temperature of tank, when T3 is higher than the preset maximum tank temperature SMX, solar pump is ceased even at the case that DT caters condition. When tank temperature drops and is 2°C below the SMX temperature, solar pump restarts when DT caters condition.

Setup steps:

To access main menu TEMP, then select submenu SMX1, "SMX1 60 °C" displays on screen.

▶ Press "SET" button, parameter "60 °C" blinks

▶ Press "+" "-" button to adjust the value of maximum temperature of tank1, adjustable range

is (2 °C~95 °C) , default set is 60 °C

▶ Repress “SET” button to activate and deactivate this function, if function deactivated, “SMX1 - - -” displays on the screen.

▶ Press “ESC” button to exit the menu or wait for 20 seconds to exit automatically, parameters are saved automatically.

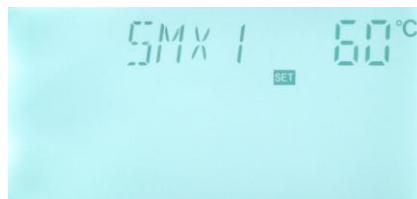

☀ SMX signal displays on screen, it indicates that this function is in activated.

6.3.8 SMX2 Maximum temperature of tank 2

Setup steps:

To access main menu TEMP, then select submenu SMX2, “SMX2 60 °C” displays on screen.

▶ Press “SET” button, parameter “60 °C” blinks

▶ Press “+” “-” button to adjust the value of the maximum temperature of tank 2 , adjustable range is (2 °C~95 °C) , default set is 60 °C



▶ Repress “SET” button to activate and deactivate this function, if function deactivated, “SMX2 - - -” displays on the screen.

▶ Press “ESC” button to exit the menu or wait for 20 seconds to exit automatically, parameters are saved automatically.

6.3.9 MAX1 Maximum switch-off temperature (for heat transferring between tank and heating loop)

Function description of heat heating - return: take system SCH7 as example

If temperature difference between tank (T4) and heating return (T6) reaches $\Delta T2$ switch-on temperature, then 3-way valve R1 is turned to heating -return, tank will heat heating-return.

When temperature difference between tank (T4) and heating return (T6) reaches $\Delta T2$ switch-off temperature, or when tank temperature T4 drops to its minimum switch-on temperature (MIN1), or when temperature of heating return rises up to its maximal switch-off temperature (MAX1), then close 3-ways valve (R1).

Setup steps:

To access main menu TEMP, then select submenu MAX1, "MAX1 60 °C" displays on the screen.

- ▶ Press "SET" button, parameter "60 °C" blinks
- ▶ Press "+" "-" button to adjust the value of maximum switch-off temperature, adjustable range is (MIN1+ 2 °C) ~ 95 °C, default set is 60 °C



- ▶ Press "ESC" button to exit the menu or wait for 20 seconds to exit automatically, parameters are saved automatically.

6.3.10 MIN1 Minimum switch-on temperature (for heat transferring between tank and heating loop)

Setup steps:

To access main menu TEMP, then select submenu MIN1, "MIN1 30 °C" displays on screen.

- ▶ Press "SET" button, parameter "30 °C" blinks
- ▶ Press "+" "-" button to adjust the value of maximum switch-off temperature, adjustable range is 10 °C ~ (MAX1- 2 °C), default set is 30 °C



- ▶ Press "ESC" button to exit the menu or wait for 20 seconds to exit automatically, parameters are saved automatically.

6.3.11 MAX2 Maximum switch-off temperature (for heat transferring between tank and heat exchanger)

Function description of heat heat-exchanger: take system SCH3 as example

In the case that collector T1, heat exchanger T4 and tank T2 all caters the switch-on DT conditions, when T4 is between the minimum switch-on temperature and the maximum switch-off temperature (MIN2<T4<MAX2), then P1,P2 triggers at the same time; when T4 is higher than the maximum switch-off temperature (T4>MAX2), P1 is ceased; when T4 is less than the minimum switch-on temperature (T4<MIN2), P2 is ceased. When collector T1, heat exchanger T4 and tank 2 caters the switch-off DT conditions, then the corresponding pump P1, P2 is ceased.

Setup steps:

To access main menu TEMP, then select submenu MAX2, "MAX2 60 °C" displays on screen.

▶ Press "SET" button, parameter "60 °C" blinks

▶ Press "+" "-" button to adjust the value of maximum switch-off temperature , adjustable range is (MIN2+ 2 °C) ~ 95 °C, default set is 60 °C



▶ Press "ESC" button to exit the menu or wait for 20 seconds to exit automatically, parameters are saved automatically.

6.3.12 MIN2 Minimum switch-on temperature (for heat transferring between tank and heat exchanger)

Setup steps:

To access main menu TEMP, then select submenu MIN2, "MIN2 30 °C" displays on screen.

▶ Press "SET" button, parameter "30 °C" blinks

▶ Press "+" "-" button to adjust the value of maximum switch-off temperature , adjustable range is 10 °C ~ (MAX2- 2 °C) , default set is 30 °C



▶ Press "ESC" button to exit the menu or wait for 20 seconds to exit automatically, parameters are saved automatically

6.3.13 T2ON Switch-on temperature for pump transferring heat from storage 1 to storage 2

Description:

Note: this function is only used in system SCH9

When T2 reaches to the preset switch-on temperature (T2ON), then circuit pump P2 is triggered to transfer heat from tank 1 to tank 2; when T2 drops to the switch-off temperature (T2OFF), circuit pump P2 is stopped.

Setup steps:

To access main menu TEMP, then select submenu T2ON, "T2ON 80 °C" displays on screen.

▶ Press "SET" button, parameter "80 °C" blinks

▶ Press “+” “-” button to adjust the minimum switch-on temperature, adjustable range is 60 °C ~90 °C, default set is 80 °C



▶ Press “ESC” button to exit the menu or wait for 20 seconds to exit automatically, parameters are saved automatically

6.3.14 T2OFF Switch-off temperature for pump transferring heat from storage 1 to storage 2

Setup steps:

To access main menu TEMP, then select submenu T2OFF, “T2OFF 60 °C” displays on screen.



▶ Press “SET” button, parameter “60 °C” blinks

▶ Press “+” “-” button to adjust the minimum switch-on temperature, adjustable range is 0 °C ~ ON-2 °C, default set is 60 °C

▶ Press “ESC” button to exit the menu or wait for 20 seconds to exit automatically, parameters are saved automatically

6.3.15 T4ON Switch-on temperature for pump transferring heat from storage 2 to storage 1

Description:

Note: this function is only used in system SCH9

When T4 reaches to the switch-on temperature (T4ON), circuit pump R1 is triggered to transfer heat energy from tank 2 to tank 1. When T4 drops to the switch-off temperature (T4OFF), circuit pump R1 is stopped.

Setup steps:

To access main menu TEMP, then select submenu T4ON, “T4ON 60 °C” displays on screen.

▶ Press “SET” button, parameter “60 °C” blinks

▶ Press “+” “-” button to adjust the minimum switch-on temperature, adjustable range is 30 °C ~60 °C, default set is 60 °C



▶ Press “ESC” button to exit the menu or wait for 20 seconds to exit automatically,

parameters are saved automatically

6.3.16 T4OFF Switch-off temperature for pump transferring heat from storage 2 to storage 1

Setup steps:

To access main menu TEMP, then select submenu T4OFF, "T4OFF 40 °C" displays on screen.



▶ Press "SET" button, parameter "40 °C" blinks

▶ Press "+" "-" button to adjust the minimum switch-on temperature, adjustable range is 0 °C ~ ON-2 °C, default set is 40 °C

▶ Press "ESC" button to exit the menu or wait for 20 seconds to exit automatically, parameters are saved automatically

6.4 PUMP circuit pump speed adjust set

Description:

P1 output can be configured to function either as RPM controlled output or simple switch output.

When nMIN is set as 30-90%, P1 output used as RPM output.

When nMIN is set as 100%, it means P1 output used as switch output.

Normal switch output: circuit pump speed control (RPM) is deactivated, pump is operated with a fixed speed, and flow rate is not changed.

RPM control output: (speed control is activated), the control system attempts to maintain a constant temperature difference between collector and tank. The pump performance is continuously adjusted, based on the temperature difference flow rate of pump is increased or reduced.

Setup steps:

To access main menu PUMP, "PUMP" displays on the screen, press "SET" to access the menu, then "nMIN 100" displays on screen.

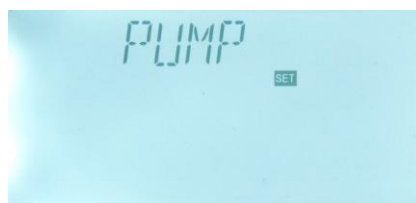

▶ Press “SET” button, parameter “100” blinks on the screen.

▶ Press “+” “-” button, to adjust pump speed. adjustable range: (30~100%) , factory set is 100%.

▶ Press “ESC” button to exit the menu or wait for 20 seconds to exit automatically, parameters are saved automatically.



6.4.1 DTS Standard temperature difference for circulation pump 1 (speed adjusting)

Description:

The preset default minimum pump speed in this controller is 30%. When the switch-on temperature difference (ΔT_{ON}) reaches, solar pump is triggered, and then within 10 seconds, pump speed increases to its minimum speed (30%). Thereafter, controller checks temperature continuously, when a standard temperature difference (DTS) reaches, the speed of pump increases one grade (10%), temperature difference RIS increases every 1°C, speed of pump increases 10% until it reaches to its maximum speed 100%. Through setting the temperature difference increase rate (RIS) can achieve the controlling of pump speed. If temperature difference drops to the switch-off temperature difference (ΔT_{OFF}), circuit pump is ceased.

Setup steps:

To access PUMP, then select submenu DTS “DTS 08 °C” displays on screen.

▶ Press “SET” button, parameter “08°C” blinks on the screen

▶ Press “+” “-” button, to adjust the standard DTS, adjustable range (2 °C~30 °C), factory set is 08°C

▶ Press “ESC” button to exit the menu or wait for 20 seconds to exit automatically, parameters are saved automatically.

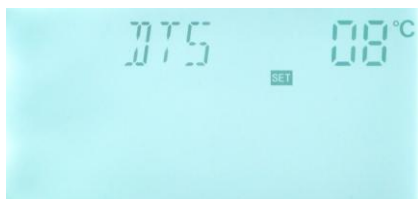

6.4.2 RIS Gain for circulation pump 1 (speed adjusting)

Setup steps:

To access menu PUMP, then select submenu RIS, “RIS 01 °C” displays on screen.

▶ Press “SET” button, parameter “01°C” blinks on the screen

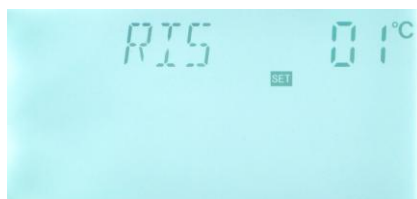

▶ Press “+” “-” button, to adjust standard RIS, adjustable range (1°C~20°C) , factory set is 1°C

▶ Press “ESC” button to exit the menu or wait for 20 seconds to exit automatically, parameters are saved automatically.

6.4.3 n2MN Speed adjusting of circulation pump 2 (pump2 RPM controlling)

Description:

P2 output can be configured to function either as RPM controlled output or simple switch output.

When n2MN is set as 30-90%, P2 output used as RPM output.

When n2MN is set as 100%, it means P2 output used as switch output. (Example: for control electromagnetic valve or control pump with integrated RPM)

Setup steps:

To select n2MN submenu (pump 2 RPM controlling), “n2MN 100” displays on screen.

▶ Press “SET” button, parameter” 100” blinks on the screen.

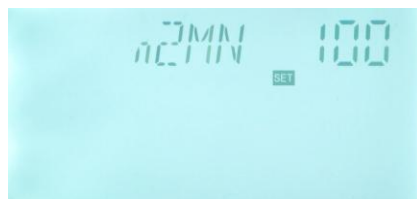

▶ Press “+” “-” button, to adjust pump speed. adjustable range: (30~100%) , factory set is 100%.

▶ Press “ESC” button to exit the menu or wait for 20 seconds to exit automatically, parameters are saved automatically.

6.4.4 DT2S Standard temperature difference for circulation pump 2 (speed adjusting)

Setup steps:

To access PUMP, then select submenu DT2S, “DT2S 08°C” displays on screen.

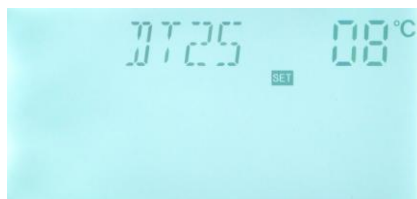

▶ Press “SET” button, parameter “08°C” blinks on the

screen

▶ Press “+” “-” button, to adjust the standard DT2S, adjustable range (2 °C~30 °C) , factory set is 08 °C

▶ Press “ESC” button to exit the menu or wait for 20 seconds to exit automatically, parameters are saved automatically.

6.4.5 RIS2 Gain for circulation pump 2 (speed adjusting)

Setup steps:

To access menu PUMP, then select submenu RIS2, “RIS2 01 °C” displays on screen.



▶ Press “SET” button, parameter “01 °C” blinks on the screen

▶ Press “+” “-” button, to adjust standard RIS2, adjustable range (1 °C~20 °C) , factory set is 1 °C

▶ Press “ESC” button to exit the menu or wait for 20 seconds to exit automatically, parameters are saved automatically.

6.5 OHQM Thermal energy measuring

Description:

Controller has function for measuring the thermal energy; it can measure the energy which is transferred from collector to tank. For the sake of measuring, the temperature on flow and return pipe should be checked, and an extra flow meter should be installed on the circulation pipe, it is used for measuring the flow rate.

The thermal energy transferred by solar system is calculated with measured parameters flow rate and temperature T0 (installed on the return pipe). Thermal energy got in the current day displays in DkWh, accumulative thermal energy displays in kWh or MWh. The amount of 2 values is the total energy output.

Note: when T0 input is used, (for example, used in east/west collector), OHQM thermal energy measuring function will be deactivated. Factory set of OHQM is off.

Setup steps:

To select menu OHQM, "OHQM" displays on the screen,

▶ Press "SET" button, parameter "OHQM OFF" appears on the screen

▶ Press "SET" button, parameter "OFF" blinks on the screen

▶ Repress "SET" button to activate this function, then "OHQM ON" appears on the screen

▶ Press "ESC" button to exit the menu or wait for 20 seconds to exit automatically, parameters are saved automatically.

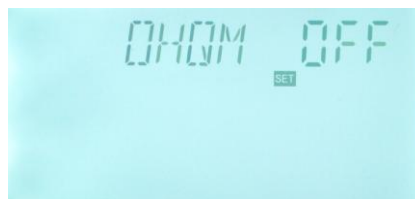

Thermal energy got in current day, accumulative thermal energy and operation time of pump can be reset, doing like following.

Operation steps: under standby status,

▶ Press "+" "-" button, select the thermal energy of current day, "DKWH XX" "SET" displays on the screen.

▶ Press "SET" button for 3 seconds, buzzer makes 3 times "du-----", the daily thermal energy is cleared, and daily thermal energy is reset to "00".

▶ Press "+" "-" button, select to check accumulative thermal energy, "KWH XX" or "MWH XX" "SET" displays on the screen.

▶ Press "SET" button for 3 seconds, buzzer makes 3 times "du-----", the sum thermal energy is cleared, and accumulative thermal energy is reset to "00".

▶ Press "+" "-" button, select the operation time of pump, "hP XX" "SET" displays on the screen.

▶ Press "SET" button for 3 seconds, buzzer makes 3 times "du-----", the operation time of pump is cleared, and it is reset to "00".

Note: Only when the thermal energy measuring function is activated, operation time of circulation pump function just can be triggered.

6.5.1 FMAX Flow rate

FAMX: Flow rate L/min. adjustable range: (0.1~20) L/min, increase rate 0.1L per button press, factory set is 2.0L/min

Setup steps:

To select submenu FMAX, "FMAX 2.0" displays on the screen.



▶ Press "SET" button, parameter "2.0" blinks on the screen

▶ Press "+" "-" button to adjust parameter of flow rate. adjustable range (0.1~20)

▶ Press "ESC" button to exit the menu or wait for 20 seconds to exit automatically, parameters are saved automatically.

Note: When select digital flow counter used in the solar system, this function is deactivated automatically.

6.5.2 MEDT Type of heat transfer liquid

MEDT: type of heat transfer liquid, adjustable range (00~03), factory set : 01

Type of heat transfer liquid:

00: Water

01: Propylene glycol

02: Glycol

03: Tyfocor LS/G-LS

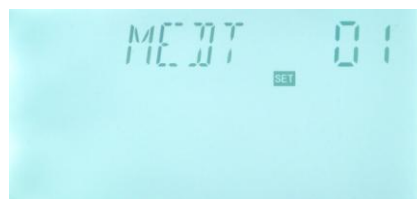

Setup steps:

To select submenu MEDT, "MEDT 01" displays on screen.

▶ Press "SET" button, parameter "01" blinks on the screen

▶ Press "+" "-" button, to adjust type of heat transfer liquid, adjustable range (00~03)

▶ Press "ESC" button to exit the menu or wait for 20 seconds to exit automatically, parameters are saved automatically.

6.5.3 MED% Concentration of heat transfer liquid

MED% Concentration of heat transfer liquid (volume percentage %), depending on the type of heat transfer liquid, adjustable range (20 ~70), factory set 40.

Setup steps:

To select submenu MED%, “MED% 40” displays on screen.

▶ Press “SET” button, parameter “40” blinks on the screen

▶ Press “+” “-” button to adjust concentration, adjustable range (20~70)

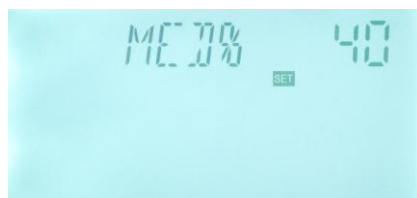

▶ Press “ESC” button to exit the menu or wait for 20 seconds to exit automatically, parameters are saved automatically.

Note: When MEDT is set as 00 or 03, then its MED% concentration doesn't appear.

6.6 PRIO Tank priority

Description:

The temperature difference between tank and collector is continuously checked, If the first priority tank is prior to the second priority tank to reaches its switch-on DT, then the first priority tank is heated first and it is heated until its temperature rises up to its maximum limited temperature; after that, the second priority tank just can be heated. If the second priority tank is prior to the first priority tank to reaches its switch-on DT, then the second priority tank is heated provisionally, but the switch-on DT conditions of first priority tanks is checked continuously, once it is catered, then the second priority tank is stopped to heat, and controller switches to heat the first priority tank. Controller repeats to check the switch-on DT every 15 minutes, and every check lasts for 2 minutes. These 2 times are the default factory set, but it can be changed at parameter tRUN and tSTP.

Tank priority function and parameters are available in system with more tanks or tank is layer heated. According to the selection of priority tank, heat energy is distributed to 2 tanks. This controller has several different priority logics for select.

1. Tank priority logic control (01,02) (01 indicates tank 1 is priority tank, 02 indicates tank 2 is priority one)

2. Continuous heating (Su1 and Su2)
3. Parallel heating (0), (that means tank priority option is deactivate. 2 tanks can be heated at the same time).

Setup steps:

To select submenu PRIO, "PRIO 01" displays on screen.

- ▶ Press "SET" button, parameter "01" blinks on the screen
- ▶ Press "+" "-" button to adjust tank priority, adjustable range: 00~02, Su1, Su2; factory set is 01.
- ▶ Press "ESC" button to exit the menu or wait for 20 seconds to exit automatically, parameters are saved automatically.



6.6.1 tRUN Interval heating timer

Description:

Interval switch-off time (TSTP), Interval heating time (TRUN), the temperature rising of collector are three important parameters for priority logic. Controller monitors whether the temperature difference between collector and tank caters the switch-on temperature difference, if DT for the priority tank isn't enough, then controller checks the next tank, if DT for the next tank caters the condition, then it is heated, but the heating duration is controlled namely by the interval heating time TRUN. TRUN time runs out, and then heating is broken off. Then control process is shifted to interval switch-off time (TSTP). Within this TSTP time, collector is heated by sun, and controller keeps on checking temperature of collector, if DT of the priority tank is still not enough, then controller continues to heat the next tank; If the priority tank DT caters the switch-on condition, then the priority tank is heated. Interval heating is no more available.

Setup steps:

To select submenu tRUN, "tRUN 15" displays on screen.

- ▶ Press "SET" button, parameter "15" blinks on the screen
- ▶ Press "+" "-" button to adjust heating time, adjustable range (01~30), factory set is 15 minutes.



► Press “ESC” button to exit the menu or wait for 20 seconds to exit automatically, parameters are saved automatically.

6.6.2 tSTP Interval switch-off time

Setup steps:

To select submenu tSTP, “tSTP 02” displays on screen.

► Press “SET” button, parameter “02” blinks on the screen

► Press “+” “-” button to adjust heating switch-off time, adjustable range (01~30) ,factory set is 02



► Press “ESC” button to exit the menu or wait for 20 seconds to exit automatically, parameters are saved automatically

| | Default set | Adjustable range |
|---------------------------------|-------------|------------------|
| Priority tank (PRIO) | 01 | 00~02、 Su1、 Su2 |
| Interval switch-off time (tSTP) | 2 minutes | 01-30 minutes |
| Interval heating time (tRUN) | 15 minutes | 01-30 minutes |

Note: if priority logic is set as Su1 or Su2, then the corresponding priority tank is heated until its maximum temperature reaches. After that, controller just heats the next tank. If the temperature of the priority tank drops below its SMX again, then when the switch-on DT conditions of priority tank caters, controller stops to heat the second tank, but switches to heat the priority tank; if the switch-on conditions of the priority tank isn't catered, then heating is stopped.

6.7 INTV Pump interval function

Description:

This function is useful when collector sensor isn't installed on collector (sensor installed on the outlet pipe of collector). In order to measure the actual temperature of collector, when circuit pump is in standby, every 30 minutes (this parameter is set at ISTP menu), solar pump is triggered to run for 15 seconds (this is set at the IRUN menu), so that the hot water inside the collector can flow into the pipe, where sensor is mounted, as the result, the actual temperature of collector is measured. It is unnecessary to activate this function in all time, you can use it within a preset time section, default set time is 07:00 ~18:00; this time can set at ISTAR and IEND submenu.

Setup steps:

To select submenu INTV, "INTV" displays on the screen.

▶ Press "SET" button to access menu, "INTV OFF" displays.



▶ Repress "SET" button, parameter "OFF" blinks, factory set is "OFF"

▶ Press "SET" button, to activate this function, then "INTV ON" displays on the screen.



▶ Press "ESC" button to exit the menu or wait for 20 seconds to exit automatically, parameters are saved automatically.

6.7.1 ISTAR Turn-on time set for pump interval running function**Setup steps:**

To select submenu ISTAR, "ISTAR 07:00" displays on the screen.

▶ Press "SET" button, parameter "07:00" blinks,

▶ Press "+" "-" button, to adjust turn-on time.



▶ Press "ESC" button to exit the menu or wait for 20 seconds to exit automatically, parameters are saved automatically.

6.7.2 IEND Turn-off time set for pump interval running function**Setup steps:**

To select submenu IEND, "IEND 18:00" displays on the screen.

▶ Press "SET" button, parameter "18:00" blinks,

▶ Press "+" "-" button, to adjust turn-off time.

▶ Press "ESC" button to exit the menu or wait for 20 seconds to exit automatically, parameters are saved automatically.



6.7.3 ISTEP Pump interval time

Setup steps:

To select submenu ISTEP, "ISTEP 30" displays on the screen.



▶ Press "SET" button, parameter "30" blinks; factory set is "30 minute"

▶ Press "+" "-" button, to adjust time, adjustable range 2~ 60 minutes.

▶ Press "ESC" button to exit the menu or wait for 20 seconds to exit automatically, parameters are saved automatically.

6.7.4 IRUN Pump running time

Setup steps:

To select submenu IRUN, "IRUN 15" displays on the screen.



▶ Press "SET" button, parameter "15" displays and blinks, factory set is "15 seconds"

▶ Press "+" "-" button, to adjust time, adjustable range 5~ 120 seconds.

▶ Press "ESC" button to exit the menu or wait for 20 seconds to exit automatically, parameters are saved automatically.

6.8 SFB Solid fuel boiler turn on/off

Description: take system SCH01 as example. Under SFB boiler is standby.

If the tank temperature T3 drops below the turn-on temperature of solid fuel boiler (SFON), and temperature of solid fuel boiler (T4) is between its MIN3 and MAX3 (MIN3< T4<MAX3), then solid fuel boiler(P2) is triggered; when tank temperature T3 rises up to the turn-off temperature of solid fuel boiler (SFOF), or when temperature of the solid fuel boiler(T4) exceeds its MIN3 and MAX3 (that is T4>MAX3, or T4<MIN3) , then solid fuel boiler (P2) is stopped.

Note: the preset MIN3 should be at least 1°C higher than the preset SFOF, for example: set SFON is 50°C, SFOF is 55°C, then MIN3 should be at least 1°C higher than SFON, and

namely it is 56°C. Then when the tank temperature is below 50°C, solid fuel boiler is triggered, when the tank temperature rises over 55°C, solid fuel boiler is stopped.

Setup steps:

To select submenu SFB, “SFB” displays on the screen.

▶ Press “SET” button, “SFB OFF” displays on the screen.

▶ Repress “SET” button, parameter “OFF” blinks, factory set is “OFF”

▶ Press “SET” button again to activate this function, then “SFB ON” displays on the screen.

▶ Press “ESC” button to exit the menu or wait for 20 seconds to exit automatically, parameters are saved automatically.



6.8.1 SFON Minimum turn-on temperature of tank

Setup steps:

To select submenu SFON, “SFON 50 °C” displays on the screen.

▶ Press “SET” button, parameter “50 °C” blinks on the screen.

▶ Press “+” “-” button, to adjust the turn-on temperature, adjustable range: (10 °C~OF-2 °C), factory set is : 50 °C

▶ Press “ESC”button to exit the menu or wait for 20 seconds to exit automatically, parameters are saved automatically.

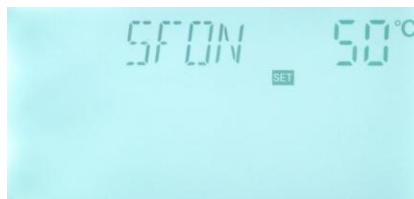

6.8.2 SFOF Maximum turn-off temperature of tank

Setup steps:

To select submenu SFOF, “SFOF 55°C” displays on the screen.

▶ Press “SET” button, parameter “55 °C” blinks on the screen.

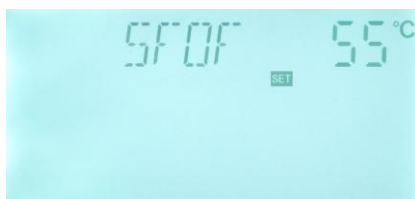

▶ Press “+” “-” button, to adjust the turn-off temperature, adjustable range:(ON+2 °C~80 °C),factory set is : 55 °C

▶ Press “ESC” button to exit the menu or wait for 20 seconds to exit automatically, parameters are saved automatically.

6.8.3 MAX3 Maximum turn-off temperature of solid fuel boiler

Setup steps:

To select submenu MAX3, “MAX3 60°C” displays on the screen.

▶ Press “SET” button, parameter “60 °C” blinks on the screen.



▶ Press “+” “-” button, to adjust the turn-off temperature, adjustable range: (MIIN3+2 °C~95 °C) ,factory set is : 60 °C

▶ Press “ESC” button to exit the menu or wait for 20 seconds to exit automatically, parameters are saved automatically.

6.8.4 MIN3 Maximum turn-on temperature of solid fuel boiler

Setup steps:

To select submenu MIN3, “MIN3 30°C” displays on the screen.

▶ Press “SET” button, parameter “30 °C” blinks on the screen.



▶ Press “+” “-” button, to adjust the turn-off temperature, adjustable range: (10 °C~MAX3-2 °C) ,factory set is : 30 °C

▶ Press “ESC” button to exit the menu or wait for 20 seconds to exit automatically, parameters are saved automatically.

6.9 FUN Auxiliary function

The auxiliary functions of this controller can be set under “FUN” menu; it is possible to activate

several auxiliary functions at the same time.

Note:

Sometimes, your selected function needs an extra signal input to connect temperature sensor or an extra output to connect pump or electromagnetic valve. When all inputs and outputs have been occupied, function you selected may not be available for activating. In such case, you can't see the submenu options. For different system, activated or deactivated statuses for following auxiliary functions in submenu are different.

Following submenu can be accessed through menu "FUN"

| Submenu under FUN | Description | Paragraph |
|-------------------|-----------------------------|-----------|
| DVWG | Anti legionnaires' function | 6.9.1 |
| FTYPE | Selection flow counter | 6.9.2 |
| COOL | Tank cooling function | 6.9.3 |
| AHO | Auto thermostat function | 6.9.4 |

6.9.1 DVWG Anti legionnaires' function

Description:

In order to avoid occurring bacteria in water tank when the temperature of tank is lower for a long time, controller will check the temperature of tank every 7 days in a period automatically, if the temperature of tank is never over 70°C during this period, then at the factory default time of 01:00 on Sunday of the period auxiliary heating system is triggered automatically to heat water until it rises up to 70°C (this is factory default set, impossible to reset), bacteria is killed by high temperature, thereafter function is deactivated.

Setup steps:

To select submenu DVWG, "DVWG ----" displays on screen. Default set is "----".

▶ Press "SET" button, parameter "----" blinks on the screen.

▶ Repress "SET" button, function is triggered. And then "70°C" blinks on the screen.



▶ Press “+” “-” button to adjust this temperature, adjustable range is: (5~95°C)。

▶ Press “ESC” button to exit the menu or wait for 20 seconds to exit automatically, parameters are saved automatically.

Note: in system SCH21-24, it is default set no anti-legionelle function, not possible to adjust.

6.9.2 FTYPE Flow counter type selection

FTYPE: flow counter type, adjustable range: (01, 02)

Type of flow counter: 01 - Mechanical flow counter

02 - Digital flow counter

Setup steps:

To select menu OHQM, then select FTYPE submenu, “FTYPE 01” displays on screen.

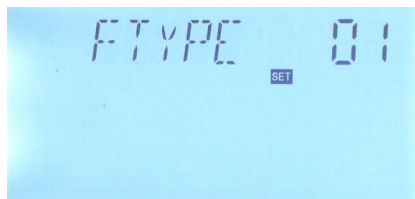

▶ Press “SET” button, parameter “01” blinks on the screen.

▶ Press “+” “-” button, select type of flow counter, adjustable range: 01, 02

▶ Press “ESC” button to exit the menu or wait for 20 seconds to exit automatically, parameters are saved automatically.

6.9.3 COOL Tank cooling function

Description:

Tank high temperature cooling function is independent of solar system’s operation, this function is used to maintains the tank with a constant temperature, so extra energy in tank will be transferred to other devices, to achieve this function, it is necessary to add a electromagnetic valve or a circuit pump R1, the corresponding tank is tank 1, its temperature is monitored by T3.

For example:

The set point of tank high temperature cooling function is 70°C, then when tank temperature (T3) rises up to 71°C, tank cooling function is activated, electromagnetic valve or circuit pump and DT circuit pump (P1) are triggered at the same time; when tank temperature (T3) drops to 67°C, electromagnetic valve or circuit pump and DT circuit pump (P1) are ceased at the same time.

Setup steps:

To select submenu COOL, “COOL ---” displays on screen.

▶ Press “SET” button, “----”blinks on the screen, default set is “---.”



▶ Repress “SET” button, to activate cooling function, and “COOL 95°C” displays on the screen, (“95°C” blinks)



▶ Press “+” “-” button to adjust function switched-on temperature, adjustable range is 5 °C ~ 120 °C。

▶ Press “ESC” button to exit the menu or wait for 20 seconds to exit automatically, parameters are saved automatically.

 This signal blinks on the screen; it indicates tank cooling function is activated.

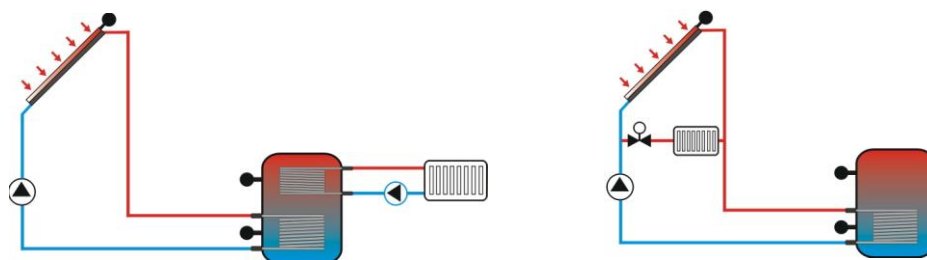

Application example for reference

6.9.4 AHO Auto thermostat function

Description:

Thermostat function keeps the tank temperature is always same, it is independent of the solar system's operation; when tank temperature is below the switch-on temperature (ATO) of this function, the function controls to trigger back-up heating device. When tank is overheated, this function will transfer heat energy from tank to other place, and ensure tank temperature is constant. For this function it is necessary to install an extra electromagnetic valve or a circuit pump P2 ,reference temperature is T4 (this function is only available in system SCH1, SCH2)

Note:

When $AHO < AHF$: This function is used to control back-up heating.

When $AHO > AHF$: This function is used to transfer energy from tank to other place, control tank temperature is constant.

2 application examples:

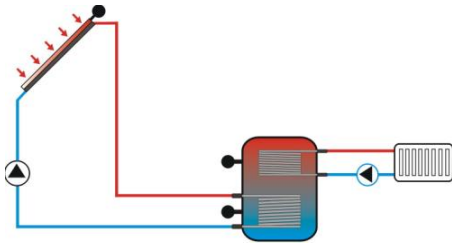

Release energy from tank

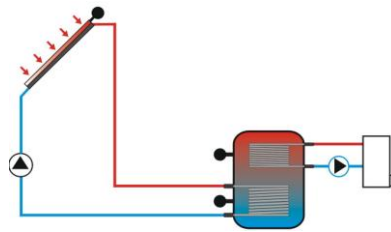

Heat tank to constant temperature

Setup steps:

To select menu AHO, “AHO ----” displays on the screen.

▶ Press “SET” button, parameter “----”blinks. Factory set “-----”.

▶ Repress “SET” button, to activate this function, and parameter “50°C”blinks on the screen.



▶ Press “+” “-” button to adjust switch-on temperature of thermostat function, adjustable range (2~95 °C)

▶ Press “ESC” button to exit menu.

▶ Press “+” button, “AHF 55°C” displays, parameter “55 °C” blinks, and factory set “55 °C”



▶ Press “+” “-” button to adjust switch-off temperature of thermostat function, adjustable range (2~95 °C)

▶ Press “ESC” button to exit the menu or wait for 20 seconds to exit automatically, parameters are saved automatically.

 Signal blinks on the screen, it indicates AHO function is activated.

Note: when any one of functions (AHO、COOL、CIRC、SFB) is activated, then other functions will be deactivated.

6.10 OSDC SD card data save function

Description:

Put the SD card in the groove, data is logged immediately. Then under menu of the OSDC card, “OSDC ON” displays automatically, it means data is logging, the interval of data log can be set. If card is full, then data logging is stopped, and CFULL displays on the screen.

6.10.1 OSDC Card function switch-on and off

Setup steps:

To select menu OSDC “OSDC” displays on the screen.

▶ Press “SET” button, “OSDC OFF” appears, in this case, data isn’t saved.

▶ Repress “SET” button, “OFF” blinks on the screen, factory default set: “OFF”.

▶ Repress “SET” button again to activate this function, and “OSDC ON” displays on the screen, start to save data now.

▶ Press “SET” button to exit the menu or wait for 20 seconds to exit automatically, parameters are saved automatically.



6.10.2 LOGI Data save intervals

Description:

By this function, SD card can save data in every 60 seconds (factory default time 60 seconds).

Setup steps:



To select menu LOGI “LOGI 60” displays on the screen.

▶ Press “SET” button to access program, “LOGI 60” appears and “60” blinks.

▶ Press “+” “-” button to adjust data save interval, adjustable range: (01~1200 seconds).

▶ Press “ESC” button to exit the menu or wait for 20 seconds to exit automatically, parameters are saved automatically.



Note: if SD card is used,  card signal will appears on the screen, if SD card is full, then data log is stopped, and  card signal blinks.

| Short message Code | Description |
|--------------------|----------------------------------|
| FSYS | File system error |
| NOCRD | NO card |
| FAT16 | Memory of card is less than 2G |
| FAT32 | Memory of card is larger than 2G |
| RTIME | Left log time (in days) |
| LOGI | Data save interval(in minutes) |
| LOGG | LOG is possible |
| WRITR | Card written protection |

6.11 UNIT Display unit °C and °F switches

Setup steps:

To select menu UNIT, "UNIT" displays on the screen.

▶ Press "SET" button to access program, "UNIT °C" appears and "°C" blinks.

▶ Press "+" "-" button to switch unit between °C and °F, factory set is °C.

▶ Press "ESC" button to exit the menu or wait for 20 seconds to exit automatically, parameters are saved automatically.



6.12 HND Manual control

When using this controller first time or when debugging this controller, output of this controller (P1, P2, H1,R1) can be triggered manually with "On, OFF" control.

Setup steps:

To access main menu HND,

▶ Press “SET” button, “HND1 off” displays on the screen,
P1 output manually set



▶ Repress “SET” button, “HND1 on” displays on the screen, P1 output is switched-on

▶ Repress “SET” again, “HND1 off” displays, P1 output is switched-off

▶ Press “ESC” to exit P1 setup.

▶ Press “+” button, “HND2 off” displays on the screen,
P2 output manually set



▶ Press “SET” button, “HND2 on” displays on the screen,
P2 output is switched-on

▶ Repress “SET” again, “HND2 off” displays, P2 output is switched-off

▶ Press “ESC” to exit P2 setup.

▶ Press “+” button, “HND3 off” displays on the screen,
H1 output manually set



▶ Press “SET” button, “HND3 on” displays on the screen,
H1 output is switched-on

▶ Repress “SET” again, “HND3 off” displays, H1 output is switched-off

▶ Press “ESC” to exit H1 setup.

▶ Press “+” button, “HND4 off” displays on the screen, R1 output manually set

▶ Press “SET” button, “HND4 on” displays on the screen,
R1 output is switched-on



▶ Repress “SET” again, “HND4 off” displays, R1 output

is switched-off

▶ Press “ESC” to exit R1 setup.

Note: when manual mode is activated,  signal displays on the screen, after 15 minutes all outputs are switched-off, controller exits manual mode automatically.

6.13 REST Recovery to factory set

Setup steps:

To access main menu REST,

▶ Press “SET” button, “YES” displays on the screen.



▶ Hold down “SET” button, buzzer makes “du-----“ 3 times, then release “SET” button and wait for display recovery to initial interface, that means controller recovers to factory set, new paramters can be reset now.

▶ Press “ESC” button to exit set program or wait for 20 seconds to exit automatically.

6.14 PASS Password set

Setup steps:

To access main menu PASS,

▶ Press “SET” button, “PWDC 0000” appears, the left digital blinks, ask for entering current password, factory set is “0000”

▶ Press “+” “-” button to enter the first digital

▶ Reprress “SET” button, the second digital blinks

▶ Press “+” “-” button to enter the second digital

▶ Reprress “SET” button, the third digital blinks

▶ Press “+” “-” button to enter the third digital

▶ Reprress “SET” button, the fourth digital blinks

▶ Press “+” “-” button to enter the fourth digital

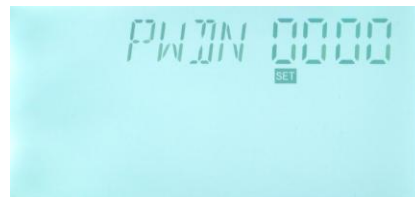

▶ Press “SET” button, “PWND 0000” displays on the screen, ask for entering a new password, doing like above to enter the new password



▶ Press “SET” button, “PWDG 0000” displays on the screen, ask for reentering the new password, doing like above to reenter the new password, “PWOK” displays on the screen to indicate reentering password successfully.



▶ Press “ESC” button to exit set program or wait for 20 seconds to exit automatically.



Warning If the password is forgot, it is not possible to recover, but you can recover the password to factory set, then you can reedit a password like above descript steps, doing like following to recover to factory set.

▶ Switch-off the power of controller firstly,

▶ Press “SET” and hold it down, then reconnect the power supply.

▶ Buzzer makes “du-----” 3 times, then release “SET” button. Controller recovers to factory set(factory set password is 0000), a new password can be reset now.

7. Button function

7.1 Holiday function

Description:

This function activates in night, solar liquid will flow from storage tank to collector to cool the tank, and therefore to prevent overheating problem of the solar system due to completely heated storage tank. The function is activated at night between 10 pm and 6 am, when the temperature of collector is 8 °C below the storage tank temperature (T2), solar circuit pump starts to work until the temperature of collector is 2 °C below the tank temperature, and then solar circuit pump is ceased.

Activate this function if:

- You intend to be absent for an extended period (holiday)
- No hot water is required for an extended period.

Note: The function is deactivated when the temperature on bottom of tank is below 35 °C.

Activate/ deactivate this function:

▶ Press  button for a long time until the signal of holiday function displays on the screen, and then holiday function is activated.

▶ Re-press  button, signal disappears, holiday function is deactivated.

Note:

This function is only activated when you are not at home for long time, when you come back; please make sure to deactivate it.

7.2 Manual heating

Description:



Electrical heater, gas or oil boiler can be as back-up devices in a solar system, this controller can achieve constant temperature controlling, when temperature of top part tank (T3) is 3 °C below the preset switch-on temperature, back-up heating will be triggered. When the temperature on the top part tank (T3) rises up to the preset temperature, then heating is ceased.

Conditions for triggering manual heating function: the preset switch-on temperature of this function should be 3 °C higher than tank temperature.

Activate/deactivate the function:

▶ Press “Heating” button, temperature “60 °C” blinks on the screen.

▶ Press “+” “-” button to adjust switch-on temperature, adjustable range 10 °C~80 °C, factory set is 60 °C.

After 20 seconds, this function is activated, signal  displays on the screen, and heating signal  blinks also.

▶ Press “Heating” button again, to switch-off manual heating function.

Note: manual heating can only heat tank one time, after manual heating is triggered, when temperature of tank rises up to the preset temperature, manual heating ceases, and manual heating function will be deactivated automatically, if customer wants to heat again, you need

redo according to above steps.

7.3 Temperature query function

Under standby status,

▶ Press “+” “-” button , you can check the value of temperature sensors T0~ T6, pump speed (n%), accumulative operation time of circuit pump (Hp), daily thermal energy (DKWH), accumulative thermal energy (KWH) or (MWH), time and date.

When checking temperature, T0 – T6 displays one by one, corresponding sensor signal  blinks. TST means the temperature of tank 1.

▶ Press “ESC” button, TST: tank 1 temperature displays.

Note:

- Since the difference of selected system, the values you can check are different.
- Daily thermal energy (DKWH) and accumulative thermal energy (KWH) or (MWH) can only be checked after triggering of OHQM thermal energy measuring function.

8. Protection function

8.1. Memory protection

In case power failure occurs, controller keeps the parameter settings unchanged.

8.2 Screen protection

When no any press on button for 3 minutes, screen protection is activated automatically, and then LCD lighting lamp is switched-off. Through press any button to light LCD lamp again.



8.3 Circuit pump protection

In the case that digital flow counter is used in the system, when controller monitors that no flow is existed, then circuit pump P1 will be stopped, and “P1” displays on the screen.













Switch-off the power supplier of controller to exit circuit pump protection function, recovery P1 to standby status.

9. Trouble shooting

9.1 Trouble protection

a. When there is a break or short circuit between the connection of temperature sensors, controller switches off the corresponding functions and no more output signals are given, at the same time error signals   show on the display. If controller does not work correctly, please check following points.



▶ Press “+” “-” button to check error code,   signal displays on the LCD screen

| Error message | CODE Meaning | Cause of error | Error rectification |
|--|--|-----------------------------|--|
|   T0 --- | T0 sensor problem | Sensor wiring short or open | Check resistance value or replace |
| | Thermal measuring function is triggered | T0 not connected | Connect T0 or switch-off function (OHQM) |
|   T1 --- | T1 sensor problem | Sensor wiring short or open | Check resistance value or replace |
|   T2 --- | T2 sensor problem | Sensor wiring short or open | Check resistance value or replace |
|   T3 --- | Appears in system with layer heated tank | T3 sensor not connected | Connect T3 sensor or switch to other system |
|   T4 --- | T4 sensor problem | Sensor wiring short or open | Check resistance value or replace |
| | AHO, SFB function is activated | T4 sensor not connected | Connect T4 sensor, deactivate functions(AHO、SFB) |
|   T6 --- | T6 sensor problem | Sensor wiring short or open | Check resistance value or replace |

9.2 Trouble checking

The controller is a qualified product, which is conceived for years of continuous trouble-free operation. If a problem occurs, the most of causes is from the peripheral components but no relation with controller itself. The following description of some well-known problems should

help the installer and operator to isolate the problem, so that the system can be put into operation as quickly as possible and to avoid unnecessary costs. Of course, not all possible problems can be listed here. However, most of the normal problems encountered with the controller can be found in the list below, only return the controller to seller when you are absolutely sure that none of the problems listed below is responsible for the fault.

| Symptoms | Secondary symptoms | Possible cause | Procedure |
|--|---|--|--|
| Controller does not appear any functions at all | Display shows nothing, no display illumination | Controller power supply is interrupted or program is out of work | Check the controller power cable and fuse |
| The solar pump doesn't operate, despite the fact that switch-on conditions are satisfied | The pump symbol on the display blinks | Pump power supply is interrupted | Check the pump power cable |
| Solar circuit pump doesn't operate | The pump symbol in the display doesn't blink.  Lighted or  blinks | The maximum storage tank temperature (SMX1) has been reached The maximum collector temperature (EM) has been reached. | No fault |
| |  Tn --- Error message displays on the screen | Sensor fault (short circuit or open circuit) | Check values of every connected sensor; replace all defective sensors and /or cabling. |
| The solar pumps operated, despite the fact that the switch-on conditions are not satisfied | The pump symbol on the display blinks. | Holiday function or Frost protection function or tank re-cooling function is activated. | No problem, it is normal. If necessary to deactivate the corresponding functions. |
| One function can't be activated | no function selected in submenu | All inputs and outputs are used; inputs and outputs can't be used doubly. | No fault on controller |



Warning! Remove the device from the mains supply before opening the case

A potentially defective sensor can be checked using an ohmmeter. To do this, the sensor must be disconnected, its resistance measured, and the value compared with the figures in the table below, small deviation ($\pm 1\%$) is acceptable,

PT1000 resistance value

| | | | | | | | | | | | | | |
|---|-------|-------|-------|------|------|------|------|------|------|-----|-----|-----|-----|
| ℃ | 0 | 10 | 20 | 30 | 40 | 50 | 60 | 70 | 80 | 90 | 100 | 110 | 120 |
| Ω | 33620 | 20174 | 12535 | 8037 | 5301 | 3588 | 2486 | 1759 | 1270 | 933 | 697 | 529 | 407 |

NTC 10K B=3950 resistance value



| | | | | | | | | | | | | | |
|---|------|------|------|------|------|------|------|------|------|------|------|------|------|
| ℃ | 0 | 10 | 20 | 30 | 40 | 50 | 60 | 70 | 80 | 90 | 100 | 110 | 120 |
| Ω | 1000 | 1039 | 1077 | 1116 | 1155 | 1194 | 1232 | 1270 | 1309 | 1347 | 1385 | 1422 | 1460 |

10. Quality Guarantee

Manufacturer provides following quality responsibilities to end-users: within the period of quality responsibilities, manufacturer will exclude the failure caused by production and material selection. A correct installation will not lead to failure. When a user takes incorrect handling way, incorrect installation, improper or crud handling, wrong connection of sensor in system and incorrect operation, the quality responsibility is invalid for them.

The warrantee expires within 24 months after the date of purchasing the controller.

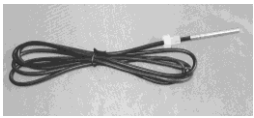
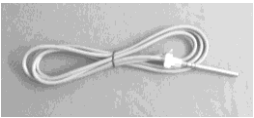
11. Accessories

| | | |
|---|---|--|
| A01: sensor for collector | PT1000, Φ6*50mm |  |
| A02: sensor for tank and pipe | NTC10K, B=3950, Φ6*50 |  |
| A05 : stainless steel thermowell | Parameter: 1/2' OT, Φ8*200 |  |
| SR802: unit for high power electrical heater | Dimension:100mmx100mmx65mm Power supply: AC180V ~ 264V, 50/60Hz Suitable power: ≤ 4000W Available ambient temperature: -10 ~ 50℃ Waterproof grade: IP43 |  |

SR802 connection diagram:

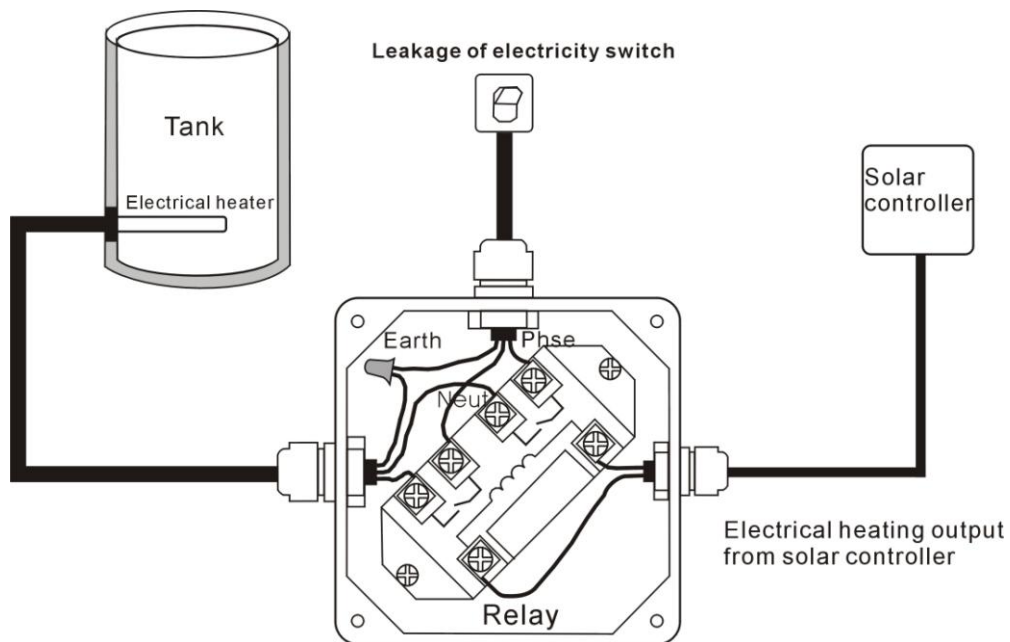

Note: switch-off power, and perform by profession installer